

SAMI GS

Frequency converters ACS501
2.2 to 75 kW

User's Manual

EN 60019134

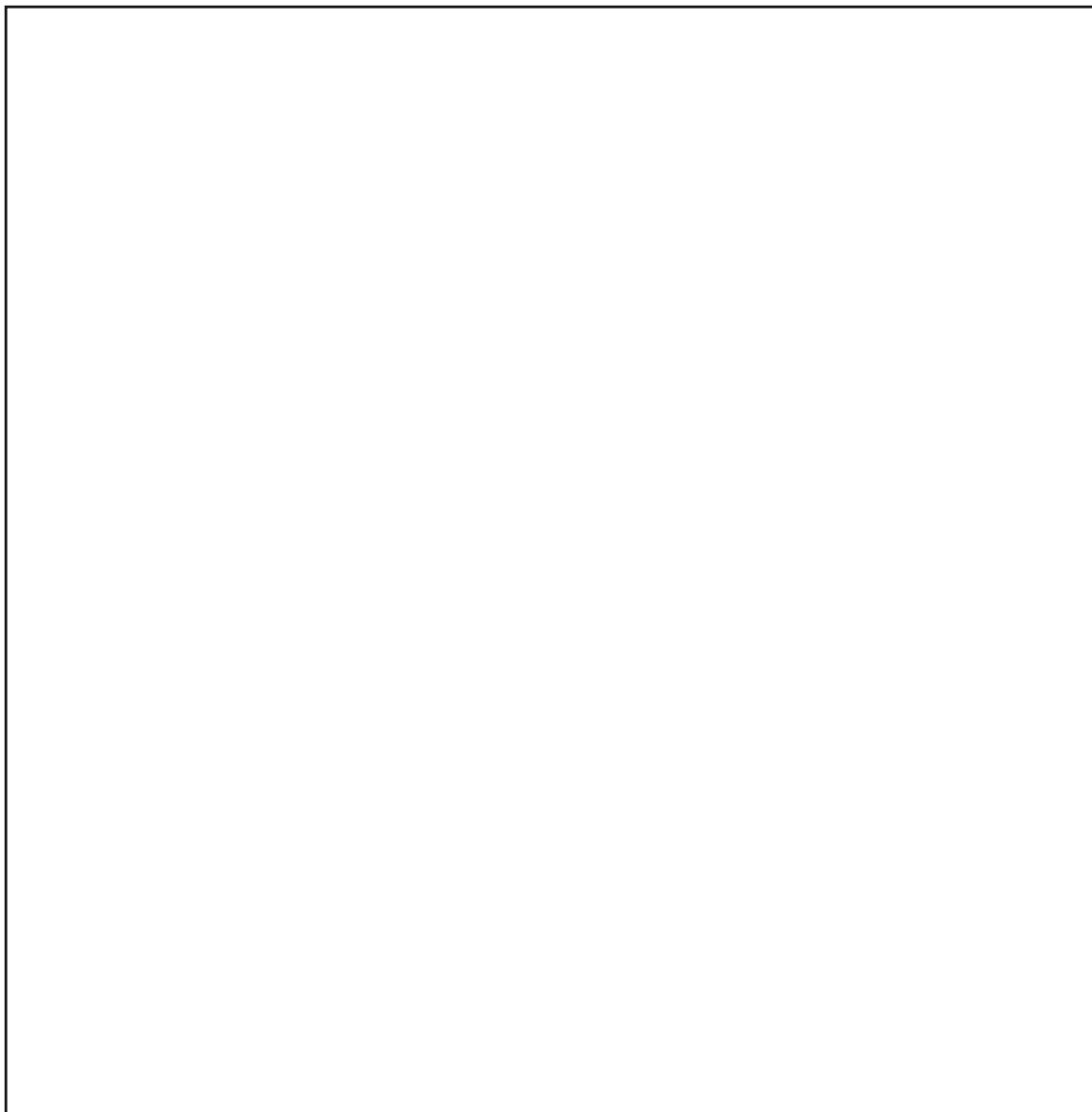

Frequency Converters ACS501
2.2 to 75 kW

User's Manual

Code: EN60019134C

GSVBC-UML1A1/EN
1995-08-07/EP

v:\markdocu\acs500\usermanu\501\en

Safety Instructions



**ONLY A COMPETENT ELECTRICIAN SHOULD
CARRY OUT THE ELECTRICAL
INSTALLATION**



SAMI GS must always be earthed through an earthing conductor connected to the earthing terminal.

If SAMI GS is connected to a system without system earth, the earth fault protection must be capable of starting at earth fault currents containing high frequency and DC components. SAMI GS' earth fault protection guards the frequency converter only against earth faults occurring in the motor or the motor cable.

Fault current circuit breakers do not necessarily operate properly with frequency converters. Circuit breaker function should be checked for possible earth fault currents arising in a fault situation.

Warning symbols

For your own safety please pay special attention to instructions containing these symbols.



Dangerous voltage



General warning

WARNINGS!

SAMI GS contains dangerous voltages when connected to the mains.

Note that the Motor Control Card of the SAMI GS is at mains supply voltage potential.

The Motor Control Card's capacitors contain dangerous DC voltage levels. After disconnecting the supply, wait at least 5 minutes after the display readout on the control panel has disappeared before taking any measurements.

Dangerous external control voltages may be present on the relay outputs of the Control Interface Card and Option Cards.

Pay attention to the following instructions:

- Do not work on the frequency converter when power is applied.
- Never connect mains voltage to drive output terminals (U_2, V_2, W_2).
- Do not make any voltage withstand tests on any part of the unit. Disconnect motor cables before taking any measurements on the motor or motor cables.
- Make sure that power factor correction capacitors are not connected between the drive and the motor.
- Do not touch the IC-circuits on the Control Interface and Motor Control Cards. Static voltage may destroy the circuit.

ALWAYS CHECK THAT SAMI GS IS SAFE BY MEASURING THE DC LINK VOLTAGE AND MAINS INPUT VOLTAGE!

Refer to the figures 5-2, 5-3 on page 18.

Contents

GENERAL

Safety Instructions	2
1 How To Use This Manual	6
2 Delivery Checks	7
3 General Information About SAMI GS	8

INSTALLATION

4 Mechanical Installation	11
4.1 Cooling	11
4.2 Mounting	14
5 Power Connections	16
5.1 Mains Cable	16
5.2 Motor Cable	16
5.3 Insulation Checks	17
5.4 Terminal Connections	17
6 Control Connections	19
6.1 Control Cables	20
6.2 Connections of the Control Interface Card SNAT 7600/7640	21

OPERATION

7 Control and Parameter Logic	22
7.1 Control Panel	22
7.2 Control Panel Operation	22
7.3 Parameter Logic	23
7.4 Adjusting Display Contrast	25
7.5 Operating Data	25
7.6 Control	27

7.7 Keypad Control	28
7.8 External Control	28
7.9 Parameter Lock	29

START-UP

8 Commissioning	29
8.1 Safety Precautions	29
8.2 Sequence of Operations	30
8.3 Installation Inspection	31
8.4 Start-Up Data Parameters	31
8.5 Checking Selected Application Macro Parameters	32
8.6 Keypad Control Test Without Motor	32
8.7 Keypad Control Test With Motor	32
8.8 Drive Parameters and Their Factory Settings (Factory Macro)	33
9 Drive Parameters	37
9.1 Main 10 - Control Connections	37
9.1.1 Group 11 - Dig/Analog Input Sel	37
9.1.2 Group 12 - Analogue Inputs	41
9.1.3 Group 13 - Ref Value Scaling	42
9.1.4 Group 14 - Output Signals	42
9.1.5 Group 15 - Analogue Outputs	44
9.1.6 Group 16 - Out Sig Scaling	45
9.1.7 Group 17 - Ext. Communication	46
9.2 Main 20 - Drive	48
9.2.1 Group 21 - Acceler/Deceler	48
9.2.2 Group 22 - Freq/Cur Limits	49
9.2.3 Group 23 - Crit Frequencies	50
9.2.4 Group 24 - Const Frequencies	51
9.2.5 Group 25 - PI-Controller	51

9.2.6 Group 26 - Start/Stop 55

9.2.7 Group 27 - Motor Control 57

9.2.8 Group 28 - PFC Control 60

9.3 Main 30 - Protection 65

9.3.1 Group 31 - Supervision 65

9.3.2 Group 32 - Fault Function 66

9.3.3 Group 33 - Automatic Reset 70

9.3.4 Group 34 - Information 70

SERVICE & MAINTENANCE

10 Fault Tracing & Service 71

10.1 Fault Indications 71

10.2 Fault Resetting 71

10.3 Fault History 71

10.4 Fault Tracing with a Fault Display 73

10.5 Service 80

10.6 Spare parts 86

11 Technical Data 88

12 Options 90

13 Glossary 91

14 Index 92

1 How To Use This Manual

The information given in this manual is valid only for SAMI GS frequency converters.

This manual gives instructions for the proper and safe installation, start-up, operation, fault tracing and service of SAMI GS frequency converters.

We recommend you read this User's Manual carefully before starting any installation and connections or operating your SAMI GS.

SAMI GS user documentation also includes an Application Macros Manual, Quick Reference Guide and Control Panel Operation Instruction sticker, which are included in the delivery. The sticker is to be placed on the front cover below the keypad.

For quick and easy use of this manual, please refer to the table of contents on pages 3 - 5 or index on pages 92 - 93.

Short explanations of some less commonly used technical terms referred to in this manual are given in the Glossary (pg. 91).

References to titles of the different sections of this manual are printed with a capital first letter. SAMI GS parameter names and settings are printed in capital letters when mentioned in the text.

Parameters are also referred to by using a number, which indicates the location of the parameter (32.1 means the first parameter in Group 32 of Main 30).

Should there be any questions concerning SAMI GS, please contact the supplier or the manufacturer.

The technical data and specifications are valid at the time of printing. We reserve the right to subsequent alterations.

ABB Industry Oy
VSD Products
P.O. Box 184
FIN-00381 Helsinki
FINLAND

Telephone: +358-0-5641
Telefax: +358-0-564 2681
Telex: +57-12440502 strfi

2 Delivery Checks

Check that the device does not show any signs of damage and that the delivery is complete (refer to the type designation code presented below). In the event of damage, please contact your insurance company or the supplier. If the delivery is not in compliance with the order, please contact the supplier immediately.

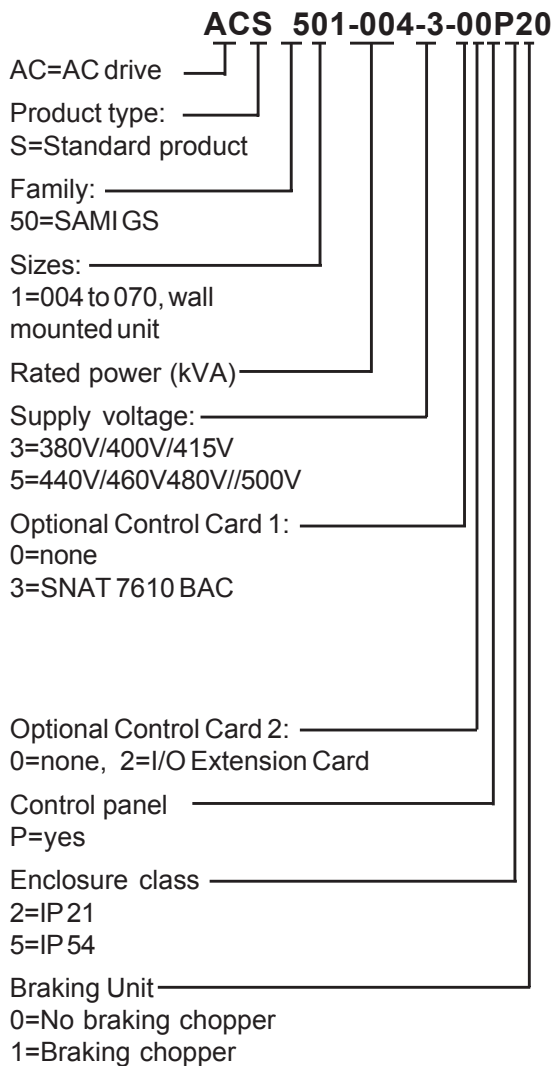

Figure 2-1. Type designation code.

Note! Do not destroy the packing. The template printed on the protective cardboard can be used for marking the fixing points of the SAMI GS on the wall.

If the device is stored before commissioning, check that the environmental conditions in the storage room are acceptable (temperature -40 °C to +70 °C; relative humidity < 95%, no condensation allowed).

The guarantee covers defects in manufacture. The manufacturer carries no responsibility for damage occurred during transport or unpacking.

Under no circumstances shall the manufacturer be liable for damages and failures due to misuse, abuse, improper installation or abnormal conditions of temperature, dust or corrosives or failures due to operation above rated capacities. Nor shall the manufacturer be liable for consequential and incidental damages.

The period of manufacturer's guarantee is 12 months from commissioning and not more than 24 months from the date of delivery.

Local ABB companies or distributors may have a different guarantee period, which is specified in their sales terms and conditions and guarantee terms.

If any queries arise concerning the SAMI GS, please contact your Distributor or ABB local office.

3 General Information About SAMI GS

The DC-Intermediate Circuit filters the pulsating DC-voltage supplied by the Rectifier Stage.

Thanks to the diode bridge, the power taken from the mains is almost entirely active power. The power factor approaches unity.

The Inverter Stage forms symmetrical three-phase AC-voltage from the constant DC-voltage supplied by the DC-Intermediate Circuit.

A Motor Control Card controls the Inverter Stage and monitors the operation of the SAMI GS.



Note! The maximum permissible number of charges within one minute is four. Therefore in applications where frequent sequential Start/Stops are required, electronic Start/Stop should be used, while the unit is powered continuously.

A Control Interface Card is the link between the operator and the SAMI. It incorporates a control panel with an alphanumeric display and keypad. A terminal block for external control connections is also located on the Control Interface Card.



Note! The Control Interface Card is galvanically isolated from the mains potential. The card is connected to earth via a 10 M Ω resistance. If needed the card can be earthed by connecting with a wire X50 terminal 8 to PE terminal on the unit frame (see Figure 6-1).

SAMI GS

**Table 3-1. SAMI GS frequency converter types for 50 Hz and 60 Hz supplies.
Mains voltage 380 V/ 400 V/ 415 V.**

Type designation	SAMI's input current I_1 , output current I_N & I_{NSQ} and motor power P_N & P_{NSQ}							
	Constant torque applications				Squared torque applications			
	Rated input current I_1/A	Rated output current I_N/A	Short term overload current ¹⁾ A	Max rated motor P_N/kW	Rated input current I_{1SQ}/A	Rated output current I_{NSQ}/A	Short term overload current ¹⁾ A	Max rated motor P_{NSQ}/kW
ACS501-004-3	4.7	6.2	9.3	2.2	6.2	7.5	8.3	3.0
ACS501-005-3	6.2	7.5	11.3	3.0	8.1	10.0	11.0	4.0
ACS501-006-3	8.1	10.0	15.0	4.0	11.0	13.2	14.5	5.5
ACS501-009-3	11.0	13.2	19.8	5.5	15.0	18.0	19.8	7.5
ACS501-011-3	15.0	18.0	27.0	7.5	21.0	24.0	26	11.0
ACS501-016-3	21.0	24.0	36.0	11.0	28.0	31.0	34	15.0
ACS501-020-3	28.0	31.0	46.5	15.0	34.0	39.0	43	18.5
ACS501-025-3	34.0	39.0	58.0	18.5	41.0	47.0	52	22.0
ACS501-030-3	41.0	47.0	70.5	22.0	55.0	62.0	68	30.0
ACS501-041-3	55.0	62.0	93.0	30.0	67.0	76.0	84	37.0
ACS501-050-3	72.0	76.0	114	37.0	85.0	89.0	98.0	45.0
ACS501-060-3	85.0	89.0	134	45.0	101	112	123	55.0

**Table 3-2. SAMI GS frequency converter types for 50 Hz and 60 Hz supplies.
Mains voltage 440 V/ 460 V/ 480 V/ 500 V.**

Type designation	SAMI's input current I_1 , output current I_N & I_{NSQ} and motor power P_N & P_{NSQ}							
	Constant torque applications				Squared torque applications			
	Rated input current I_1/A	Rated output current I_N/A	Short term overload current ¹⁾ A	Max rated motor P_N/kW	Rated input current I_{1SQ}/A	Rated output current I_{NSQ}/A	Short term overload current ¹⁾ A	Max rated motor P_{NSQ}/kW
ACS501-005-5	4.7	6.2	9.3	3.0	6.2	7.5	8.3	4.0
ACS501-006-5	6.2	7.5	11.3	4.0	8.1	10.0	11.0	5.5
ACS501-009-5	8.1	10.0	15.0	5.5	11.0	13.2	14.5	7.5
ACS501-011-5	11.0	13.2	19.8	7.5	15.0	18.0	19.8	11.0
ACS501-016-5	15.0	18.0	27.0	11.0	21.0	24.0	26	15.0
ACS501-020-5	21.0	24.0	36.0	15.0	28.0	31.0	34	18.5
ACS501-025-5	28.0	31.0	46.5	18.5	35.0	39.0	43	22.0
ACS501-030-5	35.0	39.0	58.0	22.0	41.0	47.0	52	30.0
ACS501-041-5	41.0	47.0	70.5	30.0	55.0	58.0	64	37.0
ACS501-050-5	55.0	58.0	87.0	37.0	63.0	65.0	72	45.0
ACS501-060-5	63.0	65.0	97.5	45.0	81.0	84.0	93	55.0
ACS501-070-5	81.0	84.0	126	55.0	101	112	123	75.0

¹⁾ Allowed for one minute every ten minutes.

SAMI GS

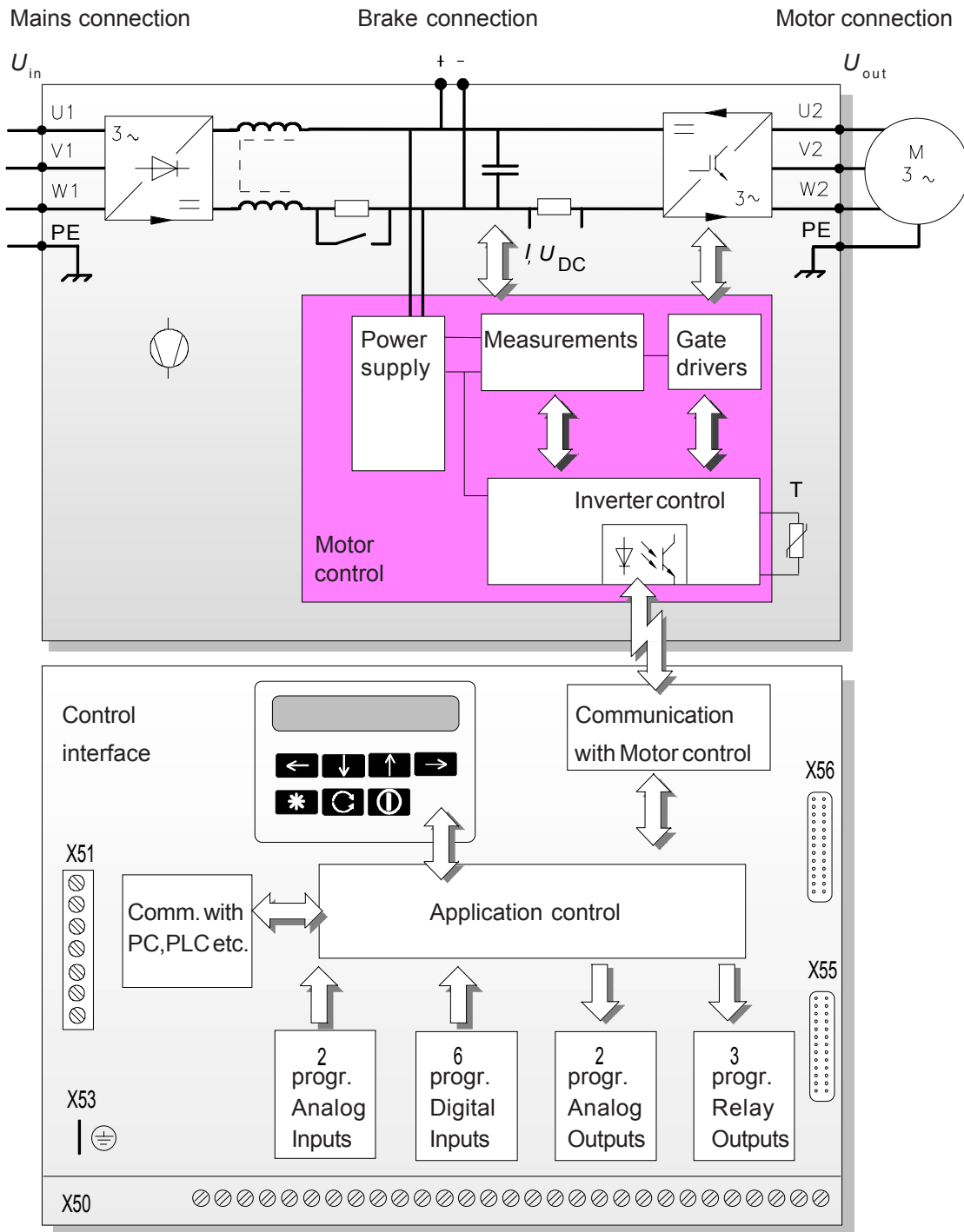

Figure 3-1. SAMI GS block scheme.

4 Mechanical Installation

SAMI GS is mounted on a wall in a vertical position using four fixing notches at the top and bottom of the unit. When choosing the mounting location pay attention to the cooling needs of the SAMI GS.

4.1 Cooling

SAMI GS frequency converters are provided with a cooling fan(s) on the bottom of the unit.

The ambient operating temperature for constant torque drives, when the load current is (I_N) and switching frequency $f_s = 3$ kHz, is 0 ... 45°C, except for ACS 501-006-3 and 009-5 0 ... 40°C. See fig. 4-2 output current derating curves. The ambient operating temperature for squared torque drives, when the load current is (I_{NSQ}) and switching frequency $f_s = 3$ kHz, is 0 ... 40°C, except for ACS 501-006-3 and 009-5 0 ... 35°C. See fig. 4-2 output current derating curves.

The cooling air must be clean and free from corrosive materials. Where necessary the cooling air should be filtered.

If the cooling air contains dust, clean the cooling surfaces of the unit regularly using compressed air and a brush.

If the cooling ability is reduced too much, the thermal protection operates causing a fault indication and stopping the frequency converter. SAMI GS can be started again when the temperature of the cooling element has fallen below the tripping level^{*)} (+70 °C). The temperature of the cooling element can be read from the control panel display (Operating Data, parameter 8, SAMI TEMPERATURE).

^{*)}for types ACS 501-050-3, 060-3, 060-5 and 070-5, the tripping level is +75°C.

Table 4-1. Required cooling air.

Type ACS 501-	[m ³ /h]
004-3...006-3, 005-5...009-5 009-3, 011-3, 011-5, 016-5 102 016-3, 020-3, 020-5, 025-5 406 025-3...060-3, 030-5...070-5	51 560

Figure 4-1. Power dissipation as a function of the switching frequency for different ACS 501 types. Output power in the following curves is P_{NSQ} .

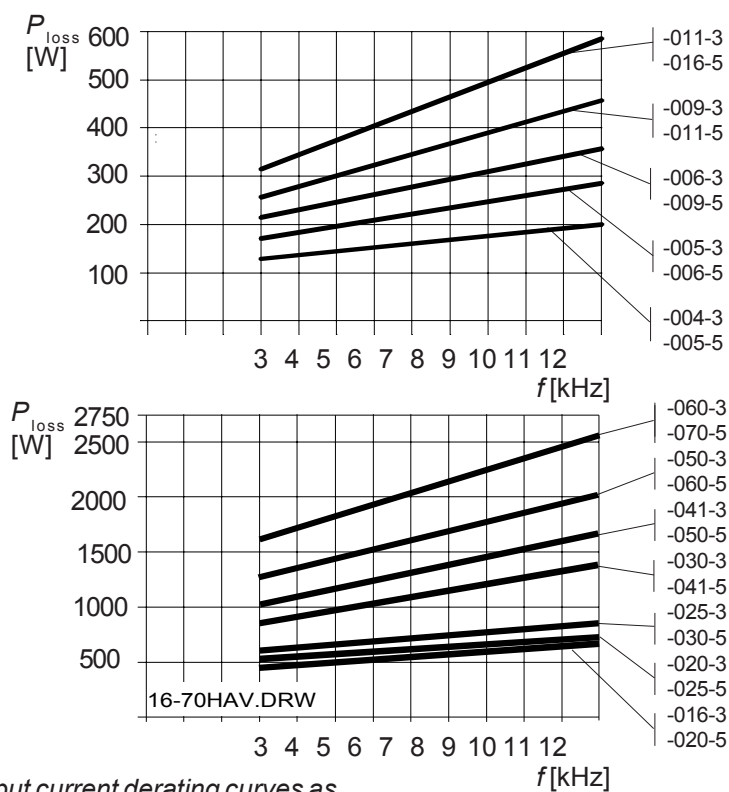
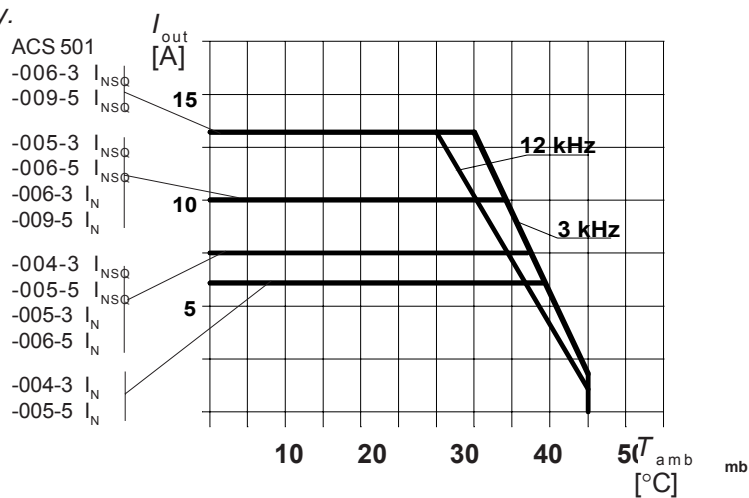
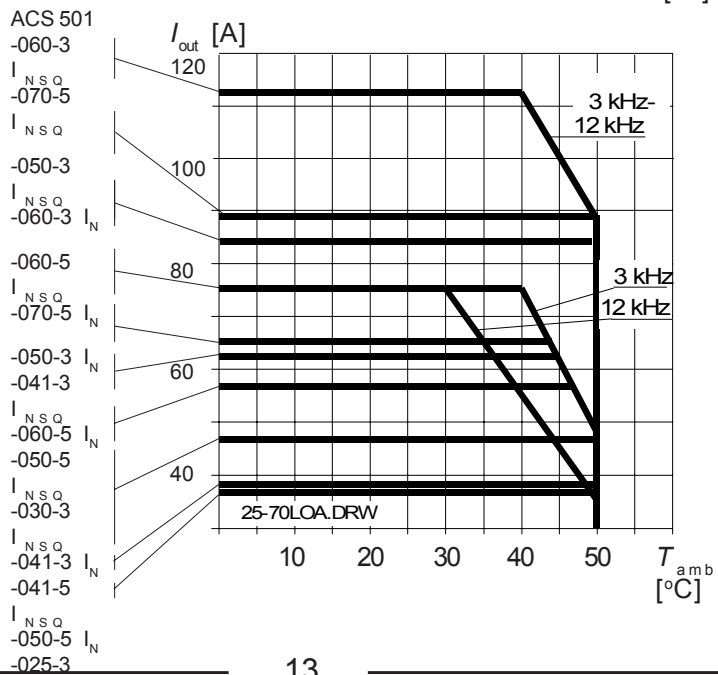
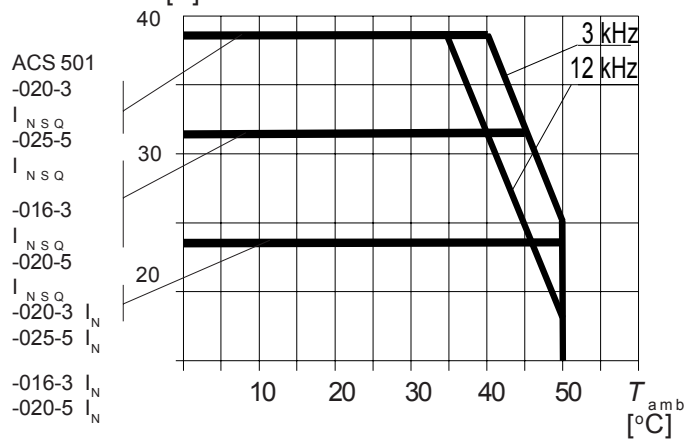
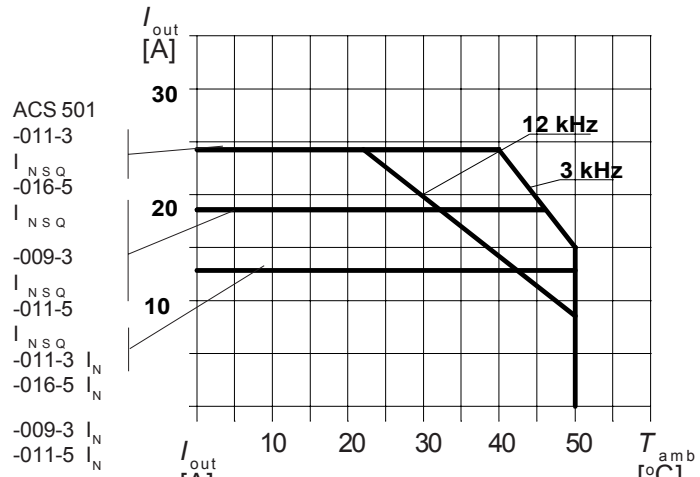
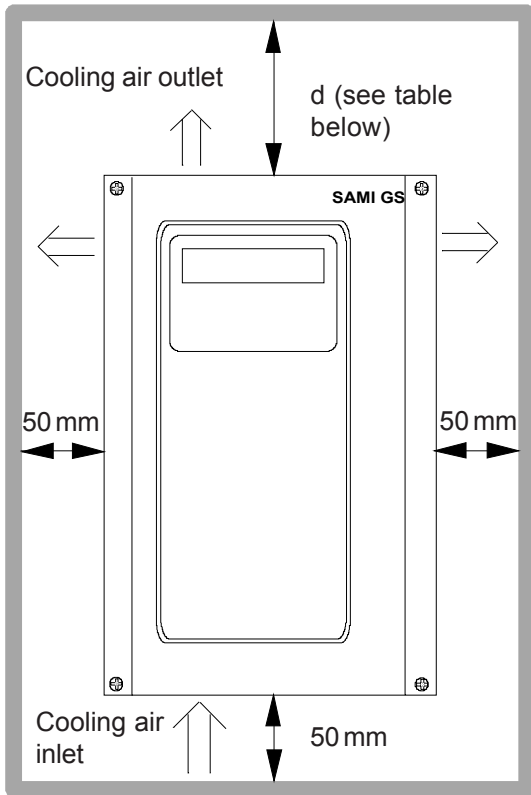

Figure 4-2. Output current derating curves as a function of ambient temperature and switching frequency.







4.2 Mounting

Note! Do not handle or lift the drive using the front cover. Use the bottom part for handling.

To ensure safe installation, check that the surface mounting is flat. Mark the fixing points of SAMI GS on the wall using the template printed on the protective cardboard package as a guide. The maximum size of the fixing screws is 6 mm (15/64") for ACS 501-004-3...006-3 and ACS 501-005-5...009-5 units and 8 mm (5/16") for 009-3...060-3 and 016-5...070-5 units.

Fix the screws to the marked positions.

Attach the unit by the fixing notches and tighten the screws.

Note! If multiple units are installed adjacent or above each other, the following minimum distances apply:
 - units side by side, clearance 100 mm - units above each other, clearance 300 mm

Type	d/[mm]
ACS501-004...011-3	150
ACS501-005...016-5	150
ACS501-016...060-3	250
ACS501-020...070-5	250

Figure 4-3. Space requirement for adequate cooling.

SAMI GS

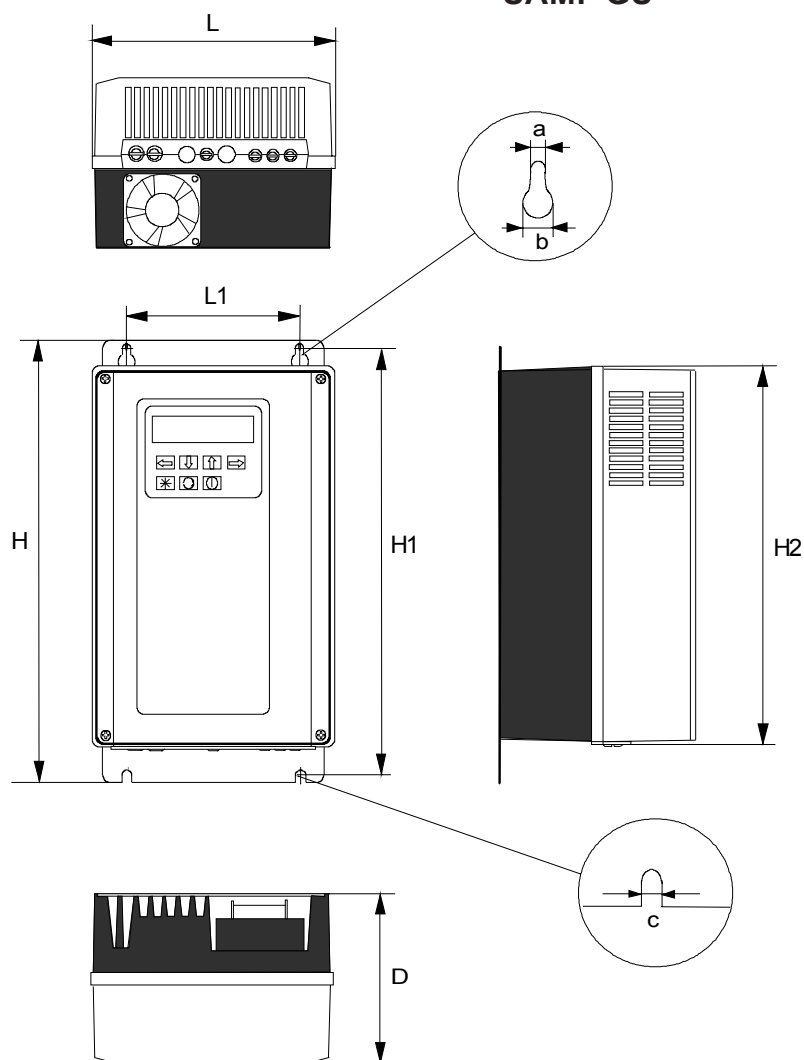

	ACS501-004...006-3	ACS501-009...011-3	ACS501-016...020-3	ACS501-025...041-3	ACS501-050,060-3
	005...009-5 (mm)	011...016-5 (mm)	020...025-5 (mm)	030...050-5 (mm)	060,070-5 (mm)
L	200	250	300	350	350
L1	150	175	225	275	275
H	362	425	507	603	603
H1	350	400	480	575	575
H2	312	380	460	551	551
D	188	208	249	262	307
a	7	9	9	9	9
b	14	18	18	18	18
c	7	9	9	9	9
Weight /kg	abt. 7.2	abt. 12	abt. 22	abt. 36	abt. 40

Figure 4-4. Dimensions of the SAMI GS unit. (Drawing presents 004...006-3)

5 Power Connections

5.1 Mains Cable

SAMI GS is rated for a 380 V/400 V/415 V or 440 V/460 V/480 V/500 V 3-phase system. A 4-conductor screened cable (three phase with Protective Earth) is recommended for the mains cabling. The cables and fuses are to be dimensioned in accordance with the output current. See Table 5-1 for minimum dimensions. When dimensioning cables, always pay attention to local authority regulations. **Note!** Remove all the compensation capacitors from the line side so that they are not powered up at the same time as the SAMI GS.

5.2 Motor Cable

A 4-conductor screened cable is recommended due to the rapid voltage changes

occurring in variable frequency motor drive systems.

To avoid disturbances

Install the motor cable away from other cable routes. Avoid long parallel runs with other cables (see page 20).

Disturbances caused by radiation from the motor cable can be reduced by mounting chokes in the motor cable. These chokes may reduce the motor voltage and the maximum. The rapid voltage changes cause capacitive current through the motor cable stray capacitances. This current rises as the switching frequency and cable length increase.

This phenomenon can cause substantially higher current measured by the SAMI GS than the actual motor current, and can cause overcurrent tripping. This means that when

Table 5-1. Mains & motor cables and fuse recommendations according to output current (I_N , I_{NSQ}).

Type ACS 501-	I_N (A)	Fuse (A)	Cu-cable (mm ²)	I_{NSQ} (A)	Fuse (A)	Cu-cable (mm ²)	Max. Cable (Cu or Al) (mm ²)
004-3/005-5	6.2	10	3*1.5+1.5	7.5	10	3*1.5+1.5	3*2.5+2.5
005-3/006-5	7.5	10	3*1.5+1.5	10.0	10	3*1.5+1.5	3*2.5+2.5
006-3/009-5	10.0	10	3*1.5+1.5	13.2	16	3*2.5+2.5	3*2.5+2.5
009-3/011-5	13.2	16	3*2.5+2.5	18.0	25	3*6.0+6.0	3*6.0+6.0
011-3/(016-5)	18.0	25	3*6.0+6.0	24.0 (26.0)	25	3*6.0+6.0	3*6.0+6.0
016-3/020-5	24.0	25	3*6.0+6.0	31.0	35	3*10+10	3*10+10
020-3/025-5	31.0	35	3*10+10	39.0	50	3*16+16	3*16+16
025-3/030-5	39.0	50	3*16+16	47.0	50	3*16+16	3*35+16
030-3/(041-5)	47.0	50	3*16+16	62.0 (58.0)	63	3*25+16	3*35+16
041-3/(050-5)	62.0 (58.0)	63	3*25+16	76.0 (65.0)	80	3*35+16	3*35+16
050-3/(060-5)	76.0 (65.0)	80	3*35+16	89.0 (84.0)	100	3*50+25	3*70+35
060-3/(070-5)	89.0 (84.0)	100	3*50+25	112	125	3*70+35	3*70+35

Table 5-2. Maximum recomm. length of the motor cable in accord. with switching frequency.

Switching frequency [kHz]	004...011-3/005...016-5			016-3...020-3/020...025-5			025-3...060-3/030-5...070-5	
	Screened cable [m]	Unscreened cable [m]		Screened cable [m]	Unscreened cable [m]		Screened cable [m]	Unscreened cable [m]
1	100	100	150	200	250			
12	50	75		75	100		150	200

cable lengths given in Table 5-2 are exceeded for types ACS 501-004...011-3 or ACS 501-005...016-5, the output choke should be used.

Note! To avoid interference problems in control cables all the cabling should be screened and should not run parallel to the motor cables (see page 20 for minimum distances).

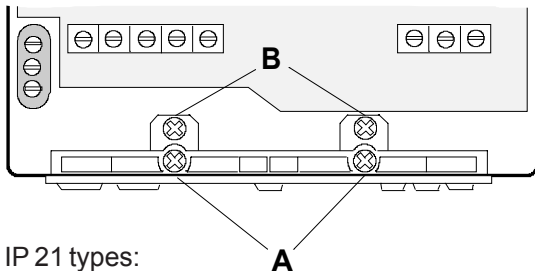

IP 21 types:
ACS 501-016...060-3, ACS 501-020...070-5
and all types as IP 54 construction, except
ACS 501-009-3, 011-3, 011-5 and 016-5.

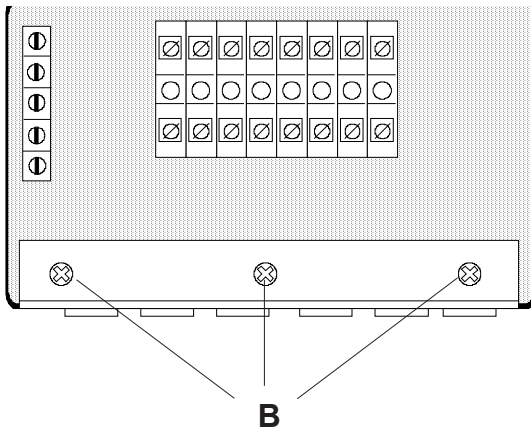

IP 54 types:
ACS 501-009-3, 011-3, 011-5 and 016-5.

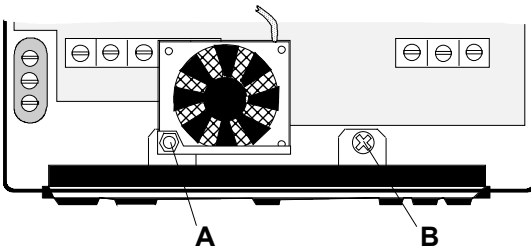

Figure 5-1. Installation of the cable entry insulator.

imum available torque. If noise problems exist, contact ABB for more detailed information.



5.3 Insulation Checks

Note! Insulation checks must be performed before connecting the SAMI to the mains. Before proceeding with the insulation resistance measurements make sure that the SAMI is disconnected from the mains.

1. Check that the motor cable is disconnected from the SAMI output on terminals U_2 , V_2 and W_2 .
2. Check that the motor cable is disconnected from the motor and remove bridging connections at the motor.
3. Measure the insulation resistances from the motor. The voltage range of the insulation resistance meter must be at least equal to the mains voltage, but not exceeding 1000 V. The insulation resistance must be greater than 1 M Ω .
4. Measure the insulation resistance of the motor cable between the phases and between each phase and Protective Earth. The insulation resistance must be greater than 1 M Ω .

5.4 Terminal Connections

To connect the power, motor and control cables, remove the front cover of the unit by removing the four screws at the corners of the cover. Then remove the front part of the cable entry insulator by removing the screws (A) at the ends of the insulator. Remove the protective caps of the cable entry holes using a knife or a screwdriver.

In order to make the cable installation easier, the cable entry insulator can be removed as one piece by unscrewing the screws (B) and pulling the insulator off the frame.

Connect the power cables in accordance with the following drawings. Attach the front part of the cable entry insulator with the screws (A) and attach the front cover of the unit by the four screws.

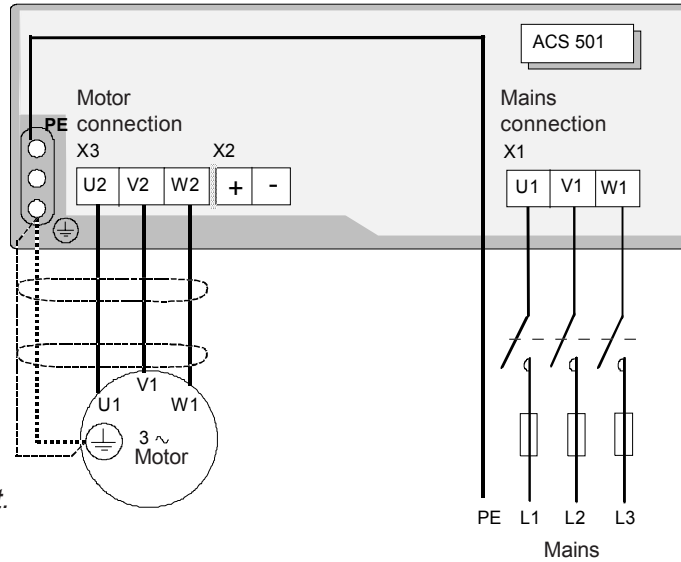

Figure 5-2. Standard Unit.

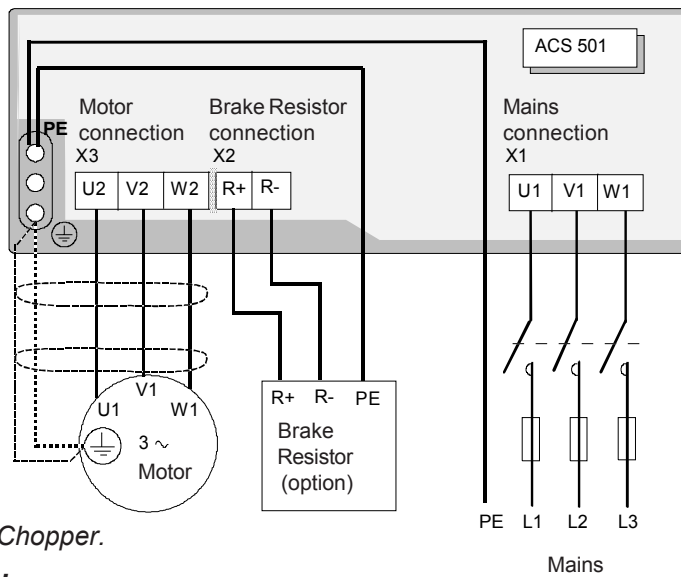

Figure 5-3. Unit with internal Braking Chopper.



WARNING!

The brake control terminals carry a dangerous DC voltage (>500V). Only an ABB dynamic braking device should be connected to terminal X2.

Note! If the motor cable has a separate screen in addition to the earth wire, the screen is connected to the PE terminal at the frequency converter end and on the motor side.

6 Control Connections

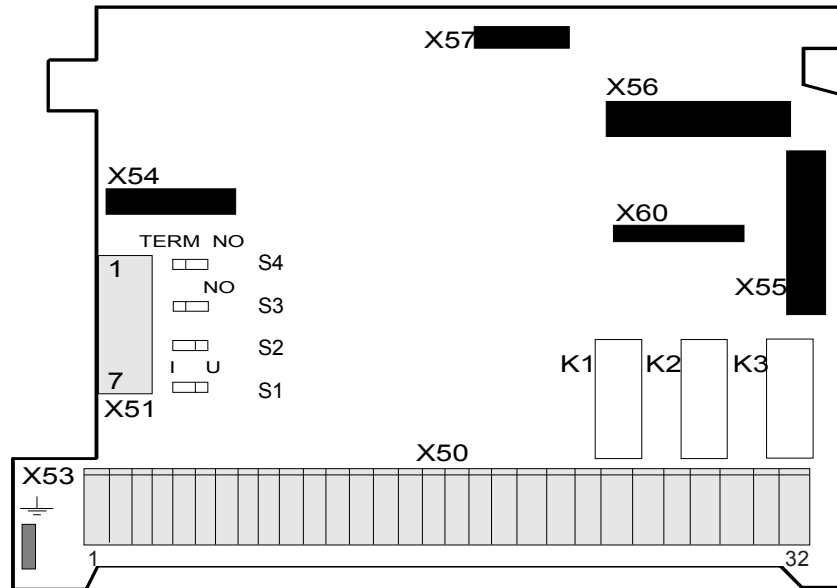

Figure 6-1. Control Interface Card SNAT 7640.

The Analogue Input signal selection is done with jumpers S1 (AI1) and S2 (AI2):
 $I = 0(4) - 20\text{mA}$, $V = 0(2) - 10\text{V}$.

X50 = screw terminal, X53 = earthing connector, X54 = connection to Motor Control Card,
 X55 and X56 = option card connectors.

X51 for RS 485 connection. Jumpers S3 and S4 are set to TERM in the last SAMI GS unit of a
 RS 485 chain.

The available control places for SAMI GS are:

- a) Keypad (see Section 7, page 22)
- b) The X50 screw terminal on the Control Interface Card SNAT 7600/7640 in the Control Unit.
- c) The RS 485 serial communication bus; terminals X51 on Control Interface Card.

External control devices, for example a PLC or a remote control panel SACE 11 PAN, are connected to the screw terminal X50 according to the connection diagram of each Application Macro. The connection

diagrams for Application Macros are presented in the Application Macro Manual.

The X50 connection diagram based on factory settings is presented in Section 6.2 on page 21. The terminal functions can be altered by means of parameter settings (refer to Section 9).

Some basic functions are selected by setting the jumpers on the Control Interface Card. Refer to Figure 6-1.

The Control Interface Card is accessible after removing the front cover of the SAMI GS.

6.1 Control Cables

Control cables for the SAMI GS should be 0.5 - 1.0 mm² screened, multi-core cables.

The cable screens should be earthed at the PE of the frequency converter chassis.

When planning the cabling between the SAMI GS and an automation device, such as a PLC, attention should be given to interference suppression, signal levels, galvanic isolation, etc. These cables should be separated from the mains and motor cables and not running in parallel with them (minimum separation 300 mm if parallel run ≤ 10 m; add 300 mm for every 10 m). There should be no additional control components (contactors or relays) inside the SAMI GS and no control cables other than those of the SAMI GS.

The control connections of the SAMI GS are galvanically isolated from mains potential and have a 10 M Ω resistance from the inverter frame i.e. PE. Because of this, there is no need to connect X50/2,4,6 and 8 (logic GND) to TE or PE. However, it could prove useful to do this if EMC problems occur.

Analogue input and output signals:

A separate twisted pair must always be used for each individual signal.

Digital inputs:

It is strongly recommended to use screened cables for digital inputs (DI). An external +24V supply for the digital inputs (DI1 to DI6) must not be used.

Relay outputs:

If relay outputs (RO) operate on 24 V DC, the signals can be routed to the same cable used for the digital inputs. If twisted cables are used, digital output and input should never be in the same pair. If 110 V/230 V AC is connected to a relay output, a separate cable without screen can be used for these signals.

Note! If the relay outputs are used to control inductive loads (e.g. relays, contactors) they

must be protected by using varistors or RC units (AC) or a diode (DC). The protection components should be installed onto the coil of the relay or contactor being controlled and not on the terminals of X50. When using an RC unit, note that the leakage current of the RC circuit must be less than the holding current of the controlled contactor or relay.

6.2 Connections of the Control Interface Card SNAT 7600/7640 (factory settings).

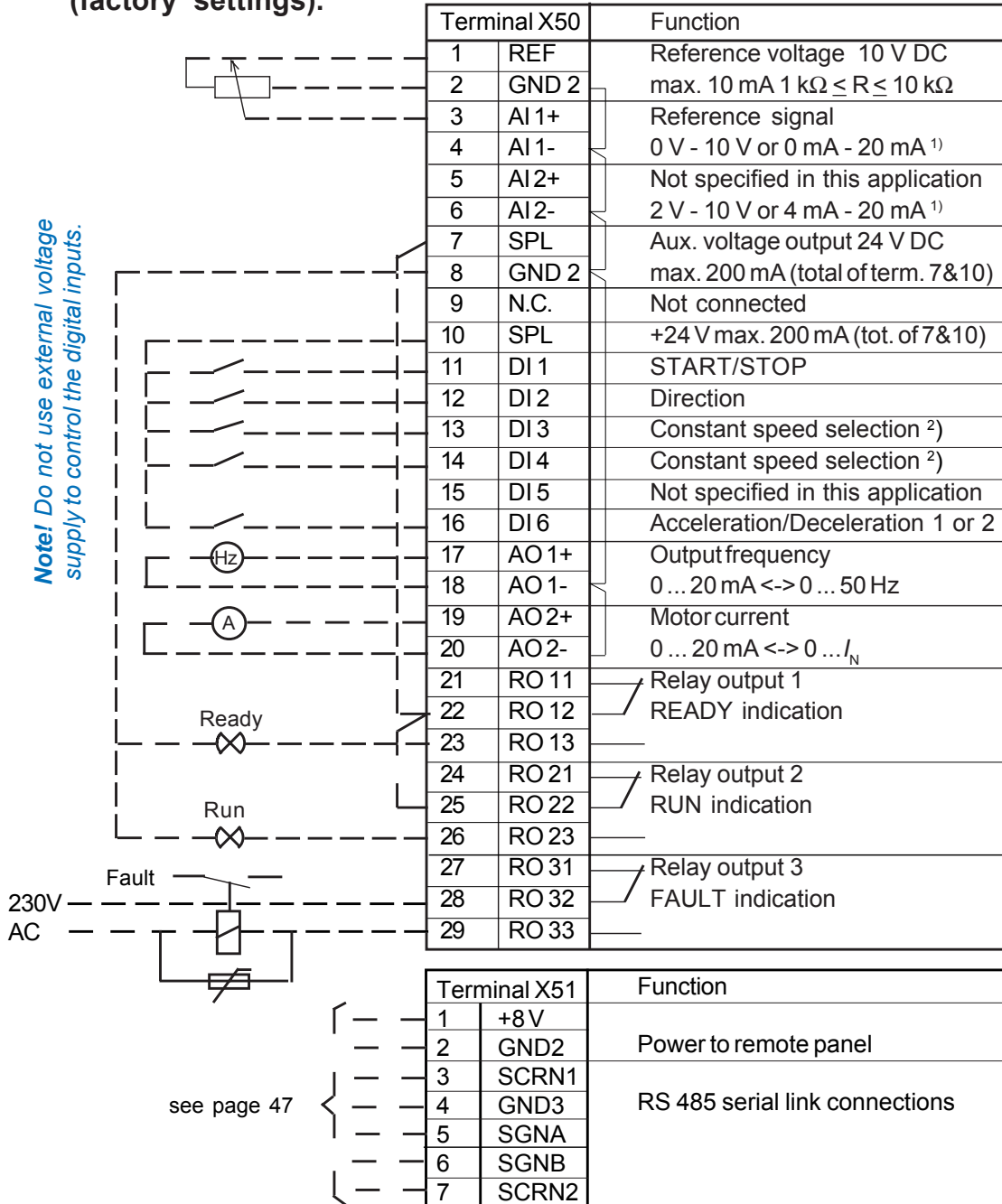

- 1) Select voltage or current reference with jumpers S1 and S2 on the Control Interface Card (located besides the terminal X51).
- 2) Refer to parameter 11.7. CONST SPEED SEL on page 40.

7 Control and Parameter Logic

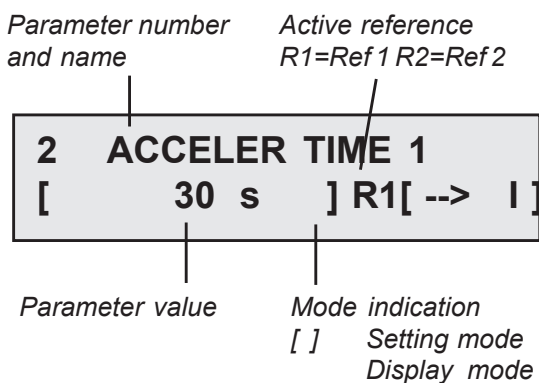
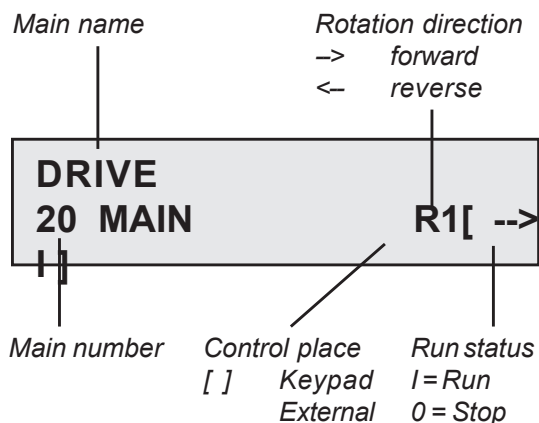

Figure 7-1. Control panel displays. Note that all the indications may not be visible at the same time.

7.1 Control Panel







The control panel, situated on top of the Control Interface Card, incorporates a 2 by 20 character, alphanumeric LCD and a keypad.



The operational information, parameters, as well as fault indications are displayed in nine languages^{*)}: English, Finnish, Swedish, German, Dutch, French, Danish, Spanish and Italian. The language selection is made in Start-Up Data Group parameter A LANGUAGE (refer to page 31).

*) Factory setting is English.

7.2 Control Panel Operation

Panel keys

-  Selects the Setting mode and saves the selected parameter value.
-  Selects Operating Data as well as Main, Group and Parameter levels. In
-  Setting mode, returns to the Display mode without changing the Parameter value.
-  In Display mode selects the next/previous Main, Group or Parameter.
-  In Setting mode increases/decreases parameter value.
-  Changes the rotation direction in Keypad control (refer to parameter 11.8 on page 40).
-  Starts and stops the motor in Keypad control. Resets faults, warnings and supervision indications.

Note! To accelerate the rate of change of parameter value, keep the  or  button depressed continuously.

7.3 Parameter Logic

Note! When the power is switched on, the last parameter displayed before the unit was switched off is displayed except for Start-up Data parameters (SAMI OUTPUT FREQ will be displayed).

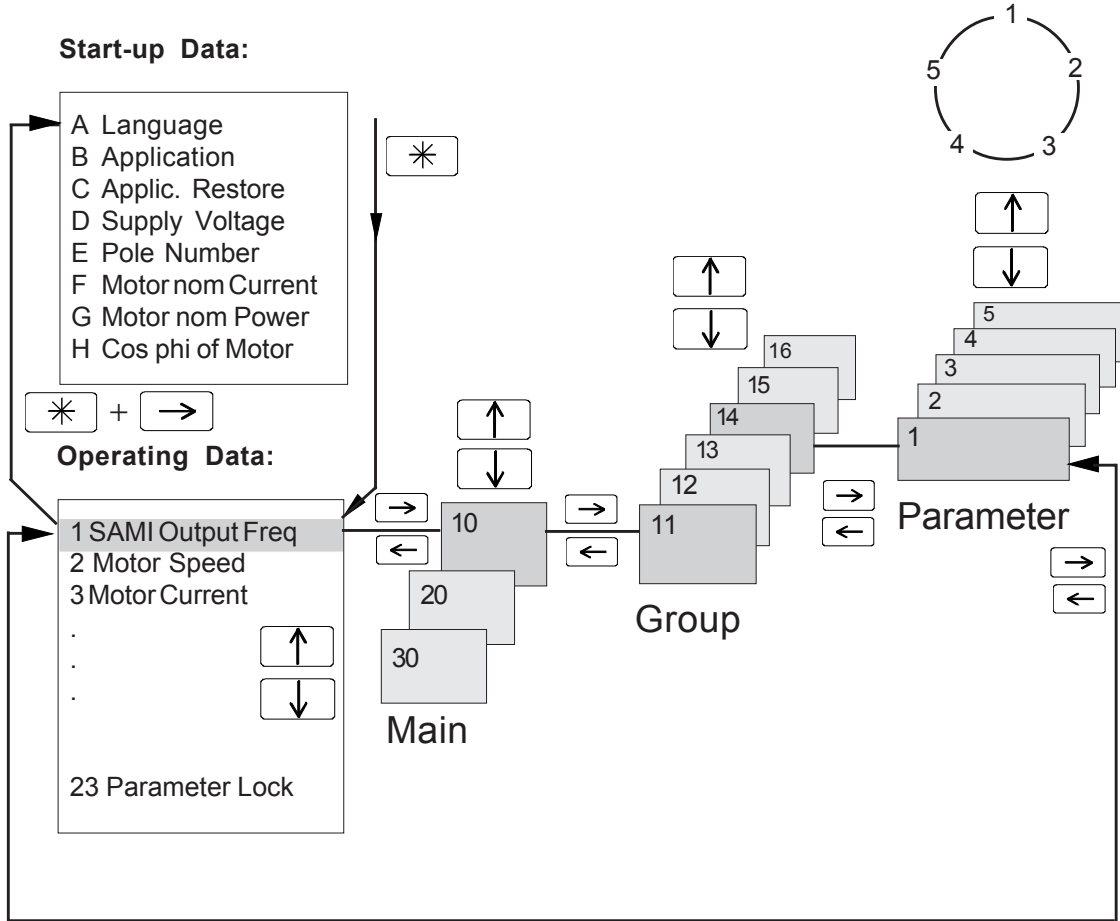

Figure 7-2. The parameters are divided into 3 Main and 19 Groups according to their function. In addition there are Operating Data parameters and Start-Up Data parameters.

Start-up Data are application and motor specific, which must be entered during commissioning.

The Operating Data display monitors values from the drive. Control place and parameter lock selection is made in this mode.

A complete table of parameters is presented on pages 33 - 36.

SAMI GS

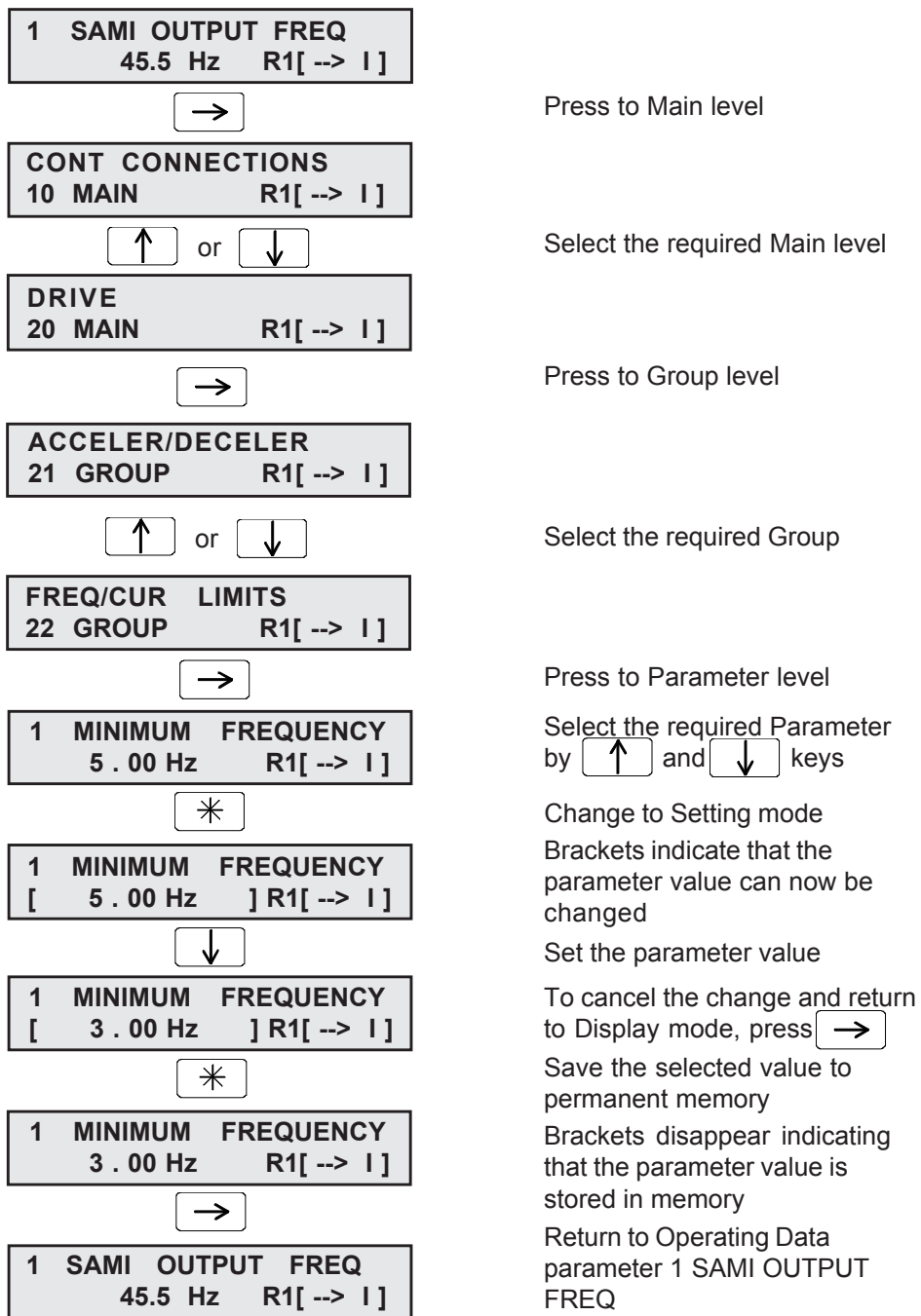

Figure 7-3. Example of control panel operation:

Let us suppose that you want to set the parameter 22.1 MINIMUM FREQUENCY to 3Hz. The following example explains the procedure.



7.4 Adjusting Display Contrast

The contrast of the LCD can be adjusted for optimal viewing. This can be done when the display is at Main or Group level.

To adjust contrast, hold down  and press  or .

It may be necessary to adjust the display contrast if the SAMI has been installed in a location with high ambient temperatures. The factory default setting is optimum for an ambient temperature between 15 °C and 30°C.

Running data and keypad control parameters

A complete description of the parameter Groups is given in chapter 9, Drive parameters. Operating Data parameters are described here.

7.5 Operating Data

The monitored values are updated five times a second. The accuracy figures given in brackets are valid for steady state signals. Actual reference signal is shown once a second if the frequency converter is stopped. **Note!** If measured value goes beyond the range of the parameter, expression marks ("!!") are shown on the display.

Parameter	Range/Unit	Description
1 SAMI Output Freq	Hz	Frequency to motor
2 Motor Speed	rpm	Actual (encoder)/calculated motor speed
3 Motor Current *)	A	Motor current ($\pm 5\%$)
4 Calcd Torque/ T_n	%	Calculated motor torque, $100 = T_M (\pm 15\%)$
5 Calcd Power/ P_n	%	Calculated motor power, $100 = P_M (\pm 15\%)$
6 DC-Voltage	V	T_M and P_M correspond to the motor data given in para. E and G of Start-up group
7 SAMI Output Volt	V	Intermediate circuit DC-voltage
8 SAMI Temperature	°C	Calculated motor voltage ($\pm 5\%$)
9 Control Place	Keypad R1/ Keypad R2/External	Temperature of the heatsink

*) This parameter indicates small current value even though the motor cables and the motor is not connected.

Operating Data continued:

Parameter	Range/Unit	Description
10 Keypad Ref 1	Hz	Control place selection (R1 = Reference 1)
11 Keypad Ref 2	%	(R2 = Reference 2)
12 Ext Ref 1 or 2	Ref1/Ref2	Frequency reference from control panel
13 External Ref 1	Hz	Controller reference from control panel
14 External Ref 2	%	External control place selection
15 Appl Block Output	Hz	External frequency reference
16 Actual Value 1*)	%	External controller reference
17 Actual Value 2*)	%	Controller output signal
18 Op-Hour Counter	h	Feedback signal for the PI-controller
19 kWh Counter	kWh	Feedback signal for the PI-controller
20 Last-Recd Fault	-	Operation hour counter
21 Second-Recd Fault	-	kWh counter
22 First-Recd Fault	-	The latest fault indication (refer to p. 71)
23 Parameter Lock	Open xxx/Locked xxx	The previous fault indication
24 Aux Motrs running**)	number	The oldest fault indication
25 Controller Output**)	%	Parameter software lock (xxx code = 358)
26 Controller deviation**)	%	Number of running constant speed (mains connected) motors
27 Act value 1 (PFC)**)	units	Output value of PI regulator. Values in % of regulation range.
28 Act value 2 (PFC)**)	units	Deviation of PI regulator in % of regulation range including sign (+ if ACT > REF, - if ACT < REF)

*) These parameters are only displayed if the PI- or PFC-Control macro is selected.

***) These parameters are displayed only if PFC-Control macro is selected.

Unscaled actual feedback signal no. 1 in units set with parameter 28.30
 Unscaled actual feedback signal no. 2 in units set with parameter 28.30

7.6 Control

The SAMI GS can be controlled from two external control places or from the Control Panel Keypad (Fig. 7-5 on page 28). The Figure below presents the standard control signal selection. How to set reference:

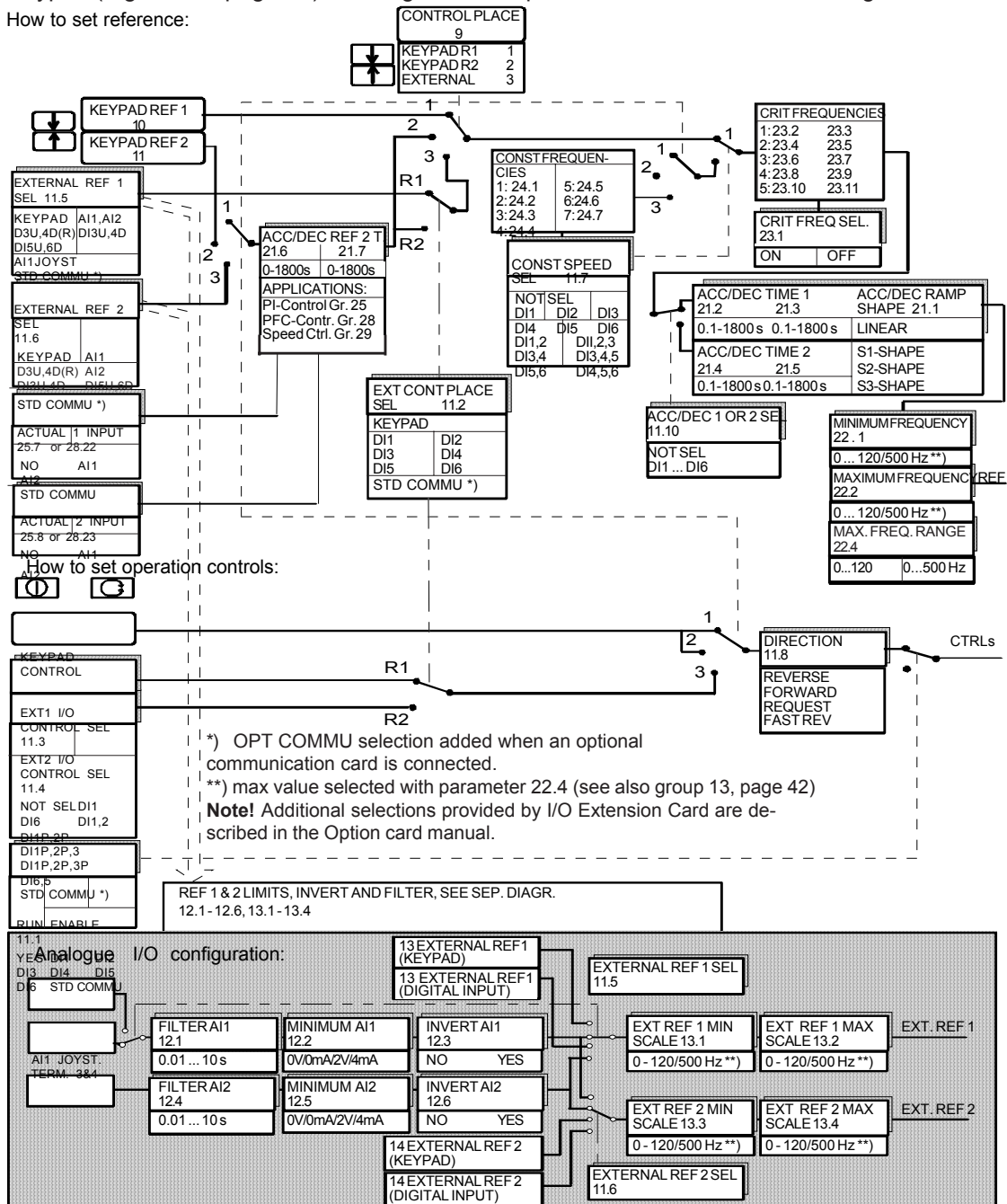
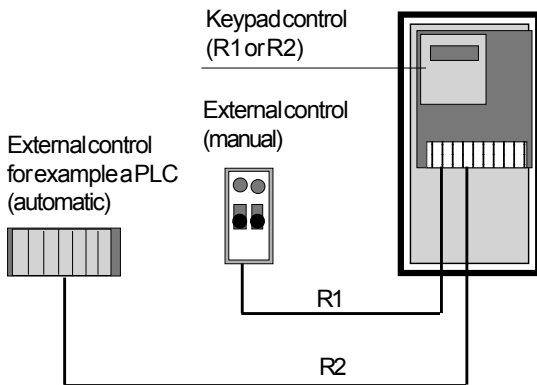

Figure 7-4. Standard control signal selections. The software switches in the diagram are set either by parameter or digital inputs, as indicated in the box at the end of the dashed line.

tions.

Select Operating Data parameter 9, CONTROL PLACE, KEYPAD R1/ KEYPAD R2 for keypad control (Control place is Ref 1 or Ref 2 accordingly) or EXTERNAL for external control. The valid control place is indicated on the display. [] around the direction and run indicators means keypad control and without [] means



external control. In addition R1 means Ref 1 and R2 Ref 2 (Figure 7-1).

Figure 7-5. Control places.

7.7 Keypad Control

When Keypad R1 or Keypad R2 is selected from Operating Data parameter 9, SAMI GS will operate according to the commands which are given via the Keypad.



= START/STOP button

= FORWARD/REVERSE button

Reference

signal = see parts Keypad Reference 1 and Keypad Reference 2

Keypad Reference 1

Operating Data parameter 10 KEYPAD REF1 is a direct frequency reference. To set

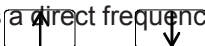

the frequency reference, select parameter 10 KEYPAD REF1, press the key and use the and keys to increase or decrease the keypad reference.

When in keypad control using reference 1, it is possible to change the keypad reference value while monitoring any of the measured values 1-8. For example, you can monitor parameter 7, SAMI OUTPUT VOLT while changing the frequency. To do this, select the measured value you prefer, press key and set the reference frequency with and keys.

If the SAMI GS is running with an external reference and the CONTROL PLACE is changed to KEYPAD R1, it is possible to transfer the current value of the external reference to KEYPAD REF1.

Example: The SAMI GS is receiving a frequency reference from a transducer via X50. You want to temporarily override the external frequency reference. Select CONTROL PLACE, KEYPAD R1 and press and . The SAMI GS puts the value of the external reference into KEYPAD REF1. You may now control the drive manually by KEYPAD REF1.

If you enter Display mode by pressing after selecting CONTROL PLACE, KEYPAD R1, the value of parameter KEYPAD REF1 will be the set MINIMUM FREQUENCY.

Keypad Reference 2

Keypad Reference 2 goes through an application block, where it can be manipulated. Keypad Reference 2 can be used as a controller reference and it can be given its own acceleration/deceleration ramps (Refer to parameters 21.6 and 21.7 on page 49).

7.8 External Control

The external control place (Ref1/Ref2) is selected with digital input 1-6 or Operating

Data parameter 12, EXT REF 1 OR 2 depending on the setting of parameter 11.2 EXT CONT PLACE SEL (Keypad, DI1-DI6).

External Reference 1

External frequency reference from control place R1. The signal source selection is made with parameter 11.5 EXTERNAL REF1 SEL. Refer to page 37 for available options.

External Reference 2

External Reference 2 goes through an application block, where it can be manipulated as Keypad Reference 2. The signal source selection is made with parameter 11.6, EXTERNAL REF2 SEL. Refer to page 37 for available options.

7.9 Parameter Lock

Parameter Lock prevents unauthorised persons altering the parameters. If parameter lock is active (Operating Data parameter 23 or digital input 1-6/parameter 11.11), it is not possible to change to Setting mode (control place can still be selected with para. 9).

The SAMI GS Parameter Lock can be controlled with the Keypad (Operating Data parameter 23) or a digital input. The control place is selected with parameter 11.11 PARAM. LOCK SEL (Keypad,DI1-DI6). To activate the Parameter Lock, set Operating Data parameter 23 PARAMETER LOCK to LOCKED xxx (control place = Keypad) or activate the selected digital input (control place = DI).

The Parameter Lock control place is indicated in Operating Data parameter 23 PARAMETER LOCK. Characters xxx after the parameter value (OPEN xxx, LOCKED xxx) indicate that the current control place is Keypad.

To open the Parameter Lock, you must enter the correct combination. The combination for all SAMI GS units is 358. When viewing PARAMETER LOCK, indent to setting mode and set the 358 code. Press  to open the Parameter Lock.

8 Commissioning

8.1 Safety Precautions

Before commissioning, observe the following warnings.

The Motor Control Card is at mains potential when the SAMI GS is connected to the mains. This voltage is extremely dangerous and can cause severe injury and even death if you come in contact with it.

When the supply voltage is disconnected, it will take about 5 minutes before the capacitors in the intermediate DC circuit are discharged to a safe voltage. Do not take any further actions within the frequency converter for at least these five minutes.

To ensure that the voltage level is safe, always measure the voltage between X2 + and - on brake terminals (see Fig. 5-2 on page 18).

Note! If internal braking option is used (terminal numbering X2: R+ and R-) measuring the voltage cannot be done safely.

The Control Interface and Optional Cards are isolated from the main circuit, BUT CAN HAVE DANGEROUS VOLTAGES present at the relay contacts, X50 terminals 21 - 29, if they are switching mains voltage. Always check for high voltage at X50 terminals 21 - 29 (and at relay contacts of Option Cards) before working on the Control Interface and Optional Cards.



When the SAMI is connected to the mains, the motor terminals U2, V2 and W2 (and the brake terminals X2) are live even when the motor is not running.

DO NOT WORK ON THE FREQUENCY CONVERTER WHEN POWER IS APPLIED!

8.2 Sequence of Operations

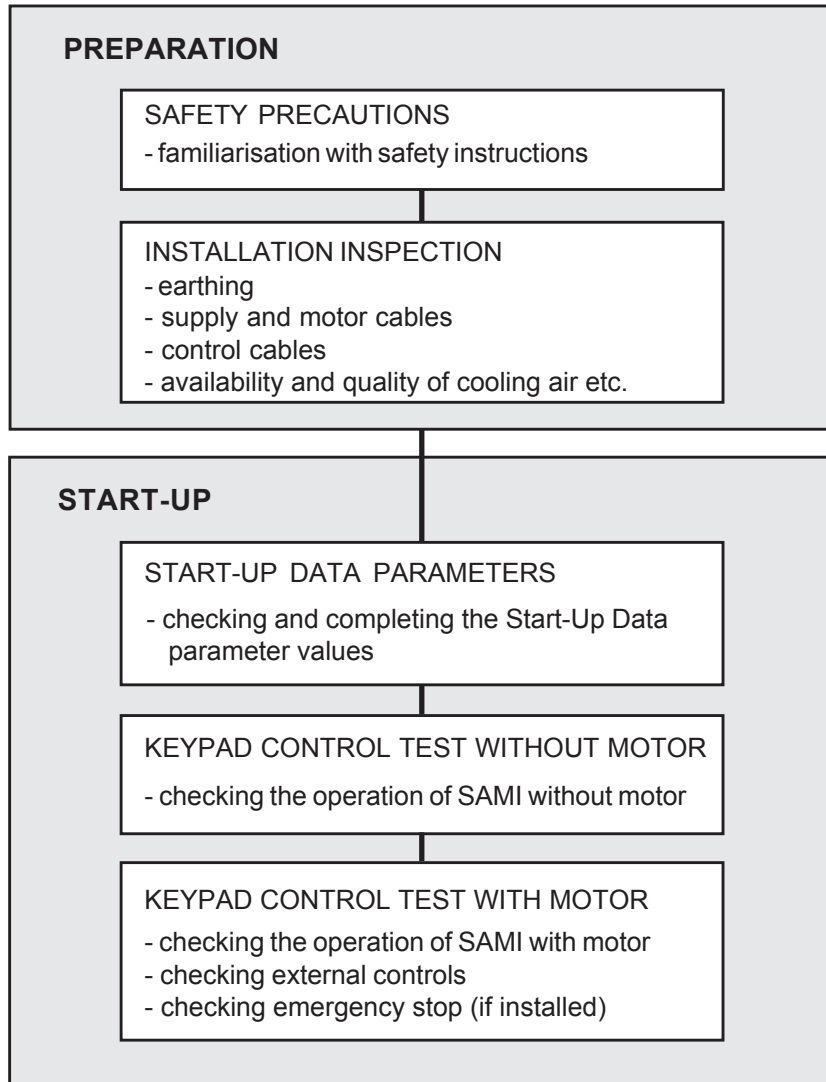

Figure 8-1. The sequence of operations during commissioning. More detailed information describing the necessary functions in each block is given on pages 29 - 32.

8.3 Installation Inspection

Inspect the mechanical and electrical installation of the SAMI for compliance with the prevailing electrical installation regulations and the installation instructions contained in Sections 4 - 6.

Note! Ensure the motor cable is disconnected before proceeding with the Keypad control test without motor (see page 32).

Ensure the following is inspected:

- protective earthing of the SAMI and the motor
- supply and motor cables (cable cross section, fuse protection, connections, cable screen earthing; see Table 5-1, 5-2 and Figure 5-2, 5-3 on pages 16 and 18)
- control cables (connections, cable screen earthing, location as far as possible from the power cables); for analogue input signal selection, see Figure 6-1
- quantity and quality of cooling air for the SAMI, see section 4.1
- check that the on/off switches of all external controls (if existing) are set to off. Make sure that starting of the motor is allowed.
- connect the SAMI to the mains. Check by measurement that the voltage between U1-V1, U1-W1 and V1-W1 is $U_N \pm 10\%$.

8.4 Start-Up Data Parameters

Power up the SAMI. The display shows Operating Data parameter 1, SAMI OUTPUT FREQ at the first power up. Before proceeding with the commissioning, check and complete the Start-Up Data parameter values.

While viewing para. 1, SAMI OUTPUT FREQ, first press and hold, then press . The display shows parameter

A LANGUAGE in Setting mode.

A LANGUAGE

Select the preferred language. Press to confirm the selection and move to the next parameter.

B APPLICATIONS

Refer to the Application Macro Manual for complete information concerning the Application Macros. Select the Application Macro which best corresponds to your application. The parameter settings in each Macro can be set separately to adapt to your application. Press to move to the next parameter.

C APPLIC. RESTORE

This parameter allows you to retrieve the factory settings of the selected Application Macro. Press to move to the next parameter.

D SUPPLY VOLTAGE (U_N)

E POLE NUMBER

F MOTOR NOM CURRENT (I_M)

G MOTOR NOM POWER (P_M)

H COS PHI OF MOTOR

Set the correct values corresponding to the supply network and the driven motor. Press to move to the next parameter.



When you have scrolled through all the parameters A-H and pressed after setting the parameter H COS PHI OF MOTOR, the display shows again Operating Data parameter 1 SAMI OUTPUT FREQ.

Note! If the nominal current of the motor is different from the nominal current of the SAMI GS, set parameter 27.3 MOTOR POWER accordingly (refer to page 57).

8.5 Checking Selected Application Macro Parameters

Selected macro parameters have default settings which suit most purposes. The parameters which are not included in the Application Macro retain the factory settings. If it is necessary to adjust the parameter values, refer to the instructions in Sections 7 and 9. Use the parameter list in the Application Macro Manual (or Table on pages 33 - 36) to record your settings. Only selected macro parameters will be displayed (e.g. Parameter group 25 for PI-Control and group 28 for PFC-Control).

8.6 Keypad Control Test Without Motor

1. If the motor is connected to the SAMI, disconnect it (after first making sure that the SAMI is disconnected from the mains).
2. Connect the SAMI to the mains and switch power on.
3. Set the DIRECTION (par. 11.8) to REQUEST.
4. Select Operating Data, 9 CONTROL PLACE, KEYPAD R1 (see Section 7, Control and Parameter Logic).
5. Return to para. 1 SAMI OUTPUT FREQ.
6. Give a start command by pushing . The run status indicator on the display should show "I".
7. Use  key to change the rotation direction. The rotation direction display should change accordingly.
8. Change to the Setting Mode and control the reference frequency. Return to Display mode by pressing .
9. Check the Operating Data parameter values.

Parameter 7, SAMI OUTPUT VOLTAGE should increase with the frequency. Programmed maximum voltage is reached at the field weakening frequency (default is 50 Hz).

10. If everything is operating normally, turn off SAMI and disconnect it from the mains.



Note! Wait at least 5 minutes after the display readout has disappeared before taking any further action within the SAMI.

(For fault tracing information, refer to Section 10 page 71)

8.7 Keypad Control Test With Motor

1. Connect the motor to the SAMI (after first making sure that the SAMI is disconnected from the mains).
2. Connect the SAMI to the mains and switch power on.
3. Select Operating Data, 9 CONTROL PLACE, KEYPAD R1 (see Section 7, Control and Parameter Logic).
4. Select KEYPAD REF 1. Choose 0.5Hz.



Warning! If rotation direction is critical, do not increase speed reference more than necessary after start to make sure the motor is running in the right direction. If the rotation direction is not correct swap 2 of the motor cable connections.

5. Give a start command by pushing .
6. Check the Operating Data parameter values for normal operation.
7. Change to Setting Mode and increase the reference. Verify that the frequency is increasing. Increase the frequency to 50 Hz. Return to Display Mode.
8. If external controls, analogue outputs, relay outputs, PI-controller or other control equipment are used in the application, check that they operate correctly.
9. Test the functioning of the emergency stop (if installed).

SAMI GS

8.8 Drive Parameters and Their Factory Settings (Factory Macro).

MAIN	GROUP	PARAMETER	DEFAULT	CUSTOMER SETTING
Operating Data (not a Main)	Operating Data	9 Control Place	Keypad R1	
		12 Ext Ref 1 or 2	Ref1	
		23 Parameter Lock	Open xxx	
	Start-Up Data	A Language	English	
		B Application	Factory	
		C Applic. Restore	No	
		D Supply Voltage	400/500 V ¹⁾	
		E Pole Number	4	
		F Motor Nom Current (I_M)	I_N of SAMI	
		G Motor Nom Power (P_M)	P_N of SAMI	
	H Cos phi of Motor	0.83		
10 Cont Connections	11 Dig/Analog Input Sel	1 Run Enable	Yes	
		2 Ext Cont Place Sel	Keypad	
		3 Ext 1 I/O Cont Sel	DI1,2	
		4 Ext 2 I/O Cont Sel	Not Sel	
		5 External Ref1 Sel	AI1	
		6 External Ref2 Sel	Keypad	
		7 Const Speed Sel	DI3,4	
		8 Direction	Request	
		9 Fault Reset Sel	Not Sel	
		10 Acc/Dec 1 or 2 Sel		
		11 Parameter Lock Sel	Keypad	
	12 Analogue Inputs	1 Filter AI1	0.1s	
		2 Minimum AI1	0V/0mA	
		3 Invert AI1	No	
		4 Filter AI2	0.1s	
		5 Minimum AI2	0V/0mA	
		6 Invert AI2	No	
	13 Ref Value Scaling	1 Ext Ref1 Min Scale	0 Hz	
		2 Ext Ref1 Max Scale	50 Hz	
		3 Ext Ref2 Min Scale	0 Hz	
		4 Ext Ref2 Max Scale	50 Hz	
	14 Output Signals	1 Analogue Out 1	Out Freq	
		2 Analogue Out 2	Out Cur	
		3 Relay RO1 Out	Ready	
		4 Relay RO2 Out	Run	
		5 Relay RO3 Out	Fault	
	15 Analogue Outputs	1 Filter AO1	2 s	
		2 Minimum AO1	0 mA	
		3 Invert AO1	No	
		4 Filter AO2	2 s	
		5 Minimum AO2	0 mA	
		6 Invert AO2	No	
	16 Out Sig scaling	1 Scale AO1	100 %	
		2 Scale AO2	100 %	
	17 Ext. Communi- cation	1 SAMI ID number	0	
		2 Bit rate select	9600 bit/s	
		3 Time-out select	100.0 s	
		4 Comms. fault funct.	None	
		5 Bad message counter	(number)	
		6 Good mess counter	(number)	

¹⁾ 400 V in 400V units, 500 V in 500 V units

SAMI GS

MAIN	GROUP	PARAMETER	DEFAULT	CUSTOMER SETTING
20 Drive	21 Acceler/Deceler	1 Acc/Dec Ramp Shape	Linear	
		2 Acceler Time 1	3 s	
		3 Deceler Time 1	3 s	
		4 Acceler Time 2	60 s	
		5 Deceler Time 2	60 s	
		6 Acceler Ref2 Time	60 s	
		7 Deceler Ref2 Time	60 s	
	22 Freq/Cur Limits	1 Minimum Frequency	0 Hz	
		2 Maximum Frequency	50 Hz	
		3 Output Current	1.5*I _N [A]	
		4 Maximum Freq. range	120 Hz	
	23 Crit Frequencies	1 Crit Freq Select	Off	
		2 Crit Freq1 Low	0 Hz	
		3 Crit Freq1 High	0 Hz	
		4 Crit Freq2 Low	0 Hz	
		5 Crit Freq2 High	0 Hz	
		6 Crit Freq3 Low	0 Hz	
		7 Crit Freq3 High	0 Hz	
		8 Crit Freq4 Low	0 Hz	
		9 Crit Freq4 High	0 Hz	
		10 Crit Freq5 Low	0 Hz	
		11 Crit Freq5 High	0 Hz	
	24 Const Frequencies	1 Const Frequency 1	5 Hz	
		2 Const Frequency 2	10 Hz	
		3 Const Frequency 3	15 Hz	
		4 Const Frequency 4	20 Hz	
		5 Const Frequency 5	25 Hz	
		6 Const Frequency 6	40 Hz	
		7 Const Frequency 7	50 Hz	
	25 PI-Controller (Parameters available only if PI- Control macro has been selected)	1 PI-Cont Gain	100 %	
		2 PI-Cont I-Time	60 s	
		3 PI-Cont Min Lim	25 Hz	
		4 PI-Cont Max Lim	50 Hz	
		5 Error Value Inv	No	
		6 Actual Value Sel	Act1	
		7 Actual 1 Input	No	
		8 Actual 2 Input	No	
		9 Actual1 Min Scale	0	
		10 Actual1 Max Scale	0	
		11 Actual2 Min Scale	0	
		12 Actual2 Max Scale	0	
	26 Start/Stop	1 Start Function	Ramp	
		2 Torque Boost Cur	1.5*I _N [A]	
3 Stop Function		Coast		
4 Brake Chopper		No		
5 DC-Holding		Off		
6 DC-Hold Voltage		0.01*U _N [V]		
7 DC-Brake Voltage		0.01*U _N [V]		
8 DC-Brake Time		0 s		

SAMI GS

MAIN	GROUP	PARAMETER	DEFAULT	CUSTOMER SETTING
20 Drive	27 Motor Control	1 Switching Freq	3 kHz	
		2 SAMI Max Out Volt	100%*U _N [V]	
		3 Motor Power	Rated	
		4 U/f Ratio	Linear	
		5 Field Weak Point	50 Hz	
		6 IR-Compensation	No	
		7 IR-Comp Voltage	0.01*U _N [V]	
		8 IR-Comp Range	0 Hz	
		9 Slip Compensation	Off	
		10 Nominal Slip	4 %	
		11 O/U Volt Control	On	
	28 PFC-Control (Parameters available only if PFC-control macro has been selected)	1 PI-cont gain	250.0 %	
		2 PI-cont I-time	3 s	
		3 Reference step 1	0 %	
		4 Reference step 2	0 %	
		5 Reference step 3	0 %	
		6 Sleep delay	60 s	
		7 Sleep level	24 Hz	
		8 Wake-up level	35.0 %	
		9 Start freq 1	51.0 Hz	
		10 Start freq 2	51.0 Hz	
		11 Start freq 3	51.0 Hz	
		12 Low freq 1	25 Hz	
		13 Low freq 2	5 Hz	
		14 Low freq 3	25 Hz	
		15 Aux mot start DLY	5 s	
		16 Aux mot stop DLY	3 s	
		17 NBR of aux motos	1	
		18 Autochang interv.	72 h	
		19 Autochange level	45.0 %	
		20 Interlocks	ON	
		21 Error value inv	NO	
22 Actual 1 input	AI 2			
23 Actual 2 input	NO			
24 Actual value sel	ACT1			
25 ACT1 min scale	100 %			
26 ACT1 max scale	100 %			
27 ACT2 min scale	100 %			
28 ACT2 max scale	100 %			
29 Regul Bypass CTRL	NO			
30 Display Unit	bar			
31 Display Unit Scale	1000			
32 NBR of Decimals	2			

SAMI GS

MAIN	GROUP	PARAMETER	DEFAULT	CUSTOMER SETTING
30 Protection	31 Supervision	1 Output Freq1 Func	No	
		2 Output Freq1 Lim	0	
		3 Output Freq2 Func	No	
		4 Output Freq2 Lim	0	
		5 Current Func	No	
		6 Current Lim	$0 \cdot I_N$ [A]	
		7 Ref1 Func	No	
		8 Ref1 Lim	0 Hz	
		9 Ref2 Func	No	
		10 Ref2 Lim	0 %	
		11 Supervis messages	Off	
	32 Fault Function	1 Serial Fault Func	Stop	
		2 AI <2V/4mA Func	No	
		3 Mot Temp Flt Func	Warning	
		4 Motor Therm Time	see Table 9-1	
		5 Motor Load Curve	150 %	
		6 External Fan	No	
		7 Stall Func	Warning	
		8 Stall Current	$1.2 \cdot I_N$ [A]	
		9 Stall Time/Freq	20 s/25 Hz	
		10 Underload Func	No	
		11 Underload Time	600 s	
		12 Underload Curve	1	
	33 Automatic Reset	1 Number of Trials	2	
		2 Trial Time	30 s	
		3 Overvoltage	No	
		4 Undervoltage	Yes	
		5 Overcurrent	No	
		6 AI Signal <2V/4mA	No	
	34 Information	1 Cri Prog Version		
		2 MC Prog Version		
		3 Test Date		

9 Drive Parameters

9.1 Main 10 - Control Connections

9.1.1 Group 11 - Dig/Analog Input Sel

These values can only be altered when the SAMI GS is stopped.

Parameter	Range/Unit	Description
1 Run Enable	Yes/DI1...DI6/Std Commu	Run enable input
2 Ext Cont Place Sel	Keypad/DI1...DI6/ Std Commu	External control place selection input
3 Ext 1 I/O Cont Sel	Not Sel/Digital Input(s) Keypad/Std Commu Refer to page 38	External control reference R1 start/stop and direction input
4 Ext 2 I/O Cont Sel	same values as para.11.3	External control reference R2 start/stop and direction input
5 External Ref1 Sel	Keypad/Analogue and Digital Inputs/Std Commu Refer to page 39	External reference 1 input
6 External Ref2 Sel	Keypad/Analogue and Digital Inputs/Std Commu Refer to page 39	External reference 2 input
7 Const Speed Sel	Not Sel/Digital Input(s) Refer to page 40	Constant frequency input
8 Direction	Reverse/Forward/ Request/Fast Rev	Rotation direction lock
9 Fault Reset Sel	Not Sel/DI1...DI6 On Stop/Std Commu	Fault/Warning/Supervision reset input Acceleration/Deceleration ramp selection
10 Acc/Dec 1or2 Sel	Not Sel/DI1...DI6	Parameter lock input
11 Param Lock Sel	Keypad/DI1...DI6	

1 Run Enable

This parameter selects the source of the Run Enable signal.

YES

Run Enable signal active.

DI1...DI6

To activate the Run Enable signal, the selected Digital Input must be connected to +24 V DC. If the Digital Input comes to 0 V DC, the drive will coast to stop.

STD COMMU

Run Enable signal can be activated via [RS 485 serial link](#).

2 Ext Cont Place Sel

This parameter defines how to select the external control place (EXT REF1/EXT REF2).

KEYPAD

The selection is made with Operating Data parameter 12 EXT REF 1 OR 2.

DI1...DI6

Choose a Digital Input; 0 V DC = EXT REF1 and +24 V DC = EXT REF2.

STD COMMU

Selection of external reference via serial link [RS 485](#).

3 Ext 1 I/O Cont Sel

4 Ext 2 I/O Cont Sel

This parameter selects the Digital Inputs used for Start/Stop and Reverse commands when using External Reference 1 (External Ref. 2).

NOT SEL

No Digital Input selected.

DI1

0 V DC = Stop and +24 V DC = Start (Rotation direction is fixed to Forward).

DI1,2

Start/Stop is connected to DI1 and Reverse to DI2. DI2 = 0 V DC = Forward and DI2 = +24 V DC = Reverse.

DI1P,2P

Start/Stop commands are given separately using pulse signals. Start is connected to DI 1 and is activated with +24 V DC pulse if Stop (DI2) is connected to +24 V DC. During normal operation, DI2 is connected to +24 V DC. If DI2 is disconnected with a pulse, SAMI GS stops.

DI1P,2P,3

DI1 and DI2 as previously. Reverse is connected to DI3. 0 V DC = Forward, +24 V DC = Reverse.

DI1P,2P,3P

Start and Reverse commands are given simultaneously with two separate pulses. Stop command is given separately. Start Forward is connected to DI1 and is activated with +24 V DC pulse if Stop (DI3) is connected to +24 V DC. Start Reverse is connected to DI2 and is activated as Start Forward. Stop is connected to DI3. During normal operation, DI3 is connected to +24 V DC. IF DI3 is disconnected with a pulse, SAMI GS stops.

DI6

DI6 = 0 V DC = Stop and DI6 = +24 V DC = Start. Rotation direction is fixed to Forward.

DI6,5

Start/Stop is connected to DI6 (as previously) and Reverse to the DI5. DI5 = 0 V DC = Forward.

KEYPAD

Start/Stop is given from the Keypad.

STD COMMU

Start/Stop from RS 485 serial link.

5 External Ref1 Sel

This parameter selects the signal source of External Reference 1.

KEYPAD

Reference is given from the Keypad (Operating Data parameter 13).

AI1,AI2

0 V DC corresponds to the set EXT REF1 MIN SCALE and 10 V DC to the set EXT REF1 MAX SCALE.

AI1 JOYST.

Joystick control. 0 V DC = EXT REF1 MAX SCALE (para. 13.2) Reverse, 5 V DC = EXT REF1 MIN. SCALE (para. 13.1), 10 V DC = EXT REF1 MAX SCALE (para. 13.2) Forward.



Warning! Use only 2-10 V (4-20 mA) signal for joystick. If a 0-10 V signal is used, the drive will run at f_{max} to Reverse if the control signal is lost. Set para. 12.2 AI1 MINIMUM to 2V/4mA and para. 32.2 AI<2V/4mA FUNC to FAULT, and the drive stops in case of lost control signal.

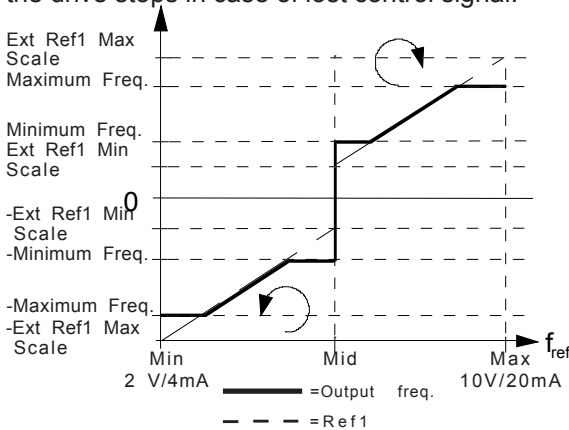

Figure 9-1. Joystick control.

DI3U,4D(R); DI3U,4D; DI5U,6D

Motor potentiometer controlled with two Digital Inputs. U = Speed up, +24 V DC; D = Speed down, +24 V DC. If DI3U,4D(R) is selected, the frequency reference is reset to the set minimum frequency, when SAMI GS is in STOP status or the SAMI's power is switched off. Acceleration and deceleration ramps are determined by parameters 21.4 and 21.5.

STD COMMU

External reference 1 via RS 485 serial link.

6 External Ref2 Sel

This parameter selects the signal source of External Reference 2.

KEYPAD

Reference is given from the Keypad (Operating Data parameter 14).

AI1,AI2

0 V DC corresponds to the set MINIMUM FREQUENCY and 10 V DC to the set MAXIMUM FREQUENCY.

DI3U,4D(R); DI3U,4D; DI5U,6D

Motor potentiometer controlled with two Digital Inputs. U = Speed up, +24 V DC, D = Speed down, +24 V DC. If DI3U,4D(R) is selected, the frequency reference is reset to the set minimum frequency, when SAMI is in STOP status or the SAMI's power is switched off. Acceleration and deceleration ramps are determined by parameters 21.4 and 21.5.

STD COMMU

External reference via RS 485 serial link.

7 Const Speed Sel

This parameter defines which Digital Inputs are used to select Constant Speeds.

NOT SEL

No Digital Input selected.

DI1 (DI2, DI3, DI4, DI5, DI6)

Constant speed number 1 (DI1 = Constant speed 1 etc.) connected to Digital Input 1. +24 V DC = Constant Speed activated.

DI1,2

Three Constant Speeds (1-3) are selected with two Digital Inputs.

DI1	DI2	
0	0	No Constant Speed
1	0	Constant Speed 1
0	1	Constant Speed 2
1	1	Constant Speed 3

DI3,4

DI5,6

Three Constant Speeds (1-3) are selected with two Digital Inputs as in DI1,2.

DI1,2,3

Seven Constant Speeds (1-7) are selected with three Digital Inputs.

DI1	DI2	DI3	
0	0	0	No Constant Speed
1	0	0	Constant Speed 1
0	1	0	Constant Speed 2
1	1	0	Constant Speed 3
0	0	1	Constant Speed 4
1	0	1	Constant Speed 5
0	1	1	Constant Speed 6
1	1	1	Constant Speed 7

DI3,4,5

DI4,5,6

Refer to DI1,2,3.

8 Direction

This parameter allows rotation direction to be fixed.

FORWARD

Direction is fixed to Forward.

REVERSE

Direction is fixed to Reverse.

REQUEST

The rotation direction is selected by Digital Inputs as defined in parameters 11.3 and 11.4 or by keypad pushbutton.

FAST REV

This function works like REQUEST. However, when parameter 26.3 STOP FUNCTION is set to COAST, the modulator starts to operate in a reverse direction immediately after Reverse is requested. This procedure results in fast reversing.

Note! Fast reverse function does not operate if the selected start function (parameter 26.1) is Flying Start (or Flying + TQB).

9 Fault Reset Sel

Fault Reset signal resets faults, warnings and supervision indications. The reset is activated by a transition from +24V to 0V.

DI1 (DI2, DI3, DI4, DI5, DI6)

Reset signal can be connected to any of the Digital Inputs 1-6.

NOT SEL

The Fault Reset function is not activated.

ON STOP

Fault is reset by Stop command (Start/Stop is selected by DI1; DI1,2 or STD COMMU as selected by parameters 11.3 and 11.4).

STD COMMU

Fault resetting via RS 485 serial link.

10 Acc/Dec 1 or 2 Sel

This parameter defines which Digital Input (1 - 6) is used to select Acceleration/Deceleration Ramp 1 or 2.
 0 V DC = Acc/Dec Time 1
 24 V DC = Acc/Dec Time 2.

11 Param. Lock Sel

This parameter selects the control place for Parameter Lock.
 If you select KEYPAD, Parameter Lock is controlled with Operating Data parameter 23, PARAMETER LOCK. If you select a Digital Input (1-6), 0 V DC = Open and +24 V DC = Locked.

9.1.2 Group 12 - Analogue Inputs

These values can be altered with the SAMI GS running.

Parameter	Range/Unit	Description
1 Filter AI1	0.01...10s	Filter time constant for AI1
2 Minimum AI1	0 V/0 mA or 2 V/4 mA	Analogue Input signal 1 minimum value
3 Invert AI1	No/Yes	Analogue Input signal 1 inversion
4 Filter AI2	0.01...10s	Filter time constant for AI2
5 Minimum AI2	0 V/0 mA or 2 V/4 mA	Analogue Input signal 2 minimum value
6 Invert AI2	No/Yes	Analogue Input signal 2 inversion

1 Filter AI1

Filter time constant for Analogue Input 1.
 63 percent of the change of the Analogue Input value takes place within the time period given by this parameter. If you select the minimum value 0.01 s, the signal is not filtered.

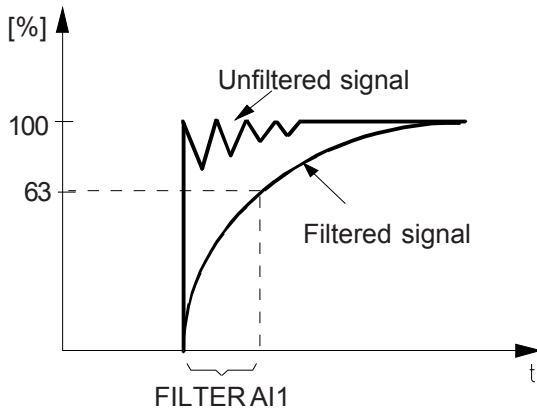

Figure 9-2. Filter time constant.

2 Minimum AI1

Analogue input signal can be set to a minimum of either 0 V/0 mA or 2 V/4 mA. The latter value provides a "living zero" function (see page 66, para. 32.2 AI<2 V/4 mA FUNC). Refer to page 19 for selection between current and voltage input.

3 Invert AI1

If you select YES, the Analogue Input 1 signal is inverted (minimum reference corresponds to maximum output frequency). This can be used, for example to invert the feedback signal to control a reference in liquid level control.

4 Filter AI2

5 Minimum AI2

6 Invert AI2

Refer to parameters 12.1 - 12.3.

9.1.3 Group 13 - Ref Value Scaling

These values can be altered with the SAMI GS running.

Parameter	Range/Unit	Description
1 Ext Ref1 Min Scale	0...120/500 Hz*)	External reference 1 minimum value Cannot be set > Ext Ref1 Max Scale
2 Ext Ref1 Max Scale	0...120/500 Hz*)	External reference 1 maximum value Cannot be set < Ext Ref1 Min Scale
3 Ext Ref2 Min Scale	0...120/500 Hz*)	External reference 2 minimum value Cannot be set > Ext Ref2 Max Scale
4 Ext Ref2 Max Scale	0...120/500 Hz*)	External reference 2 maximum value Cannot be set < Ext Ref2 Min Scale

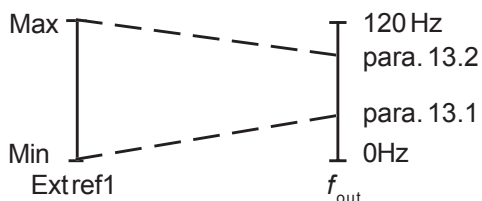

Figure 9-3. External Reference scaling.

*) Max value is set automatically according to the setting of parameter 22.4.

Note! If max./min. frequency setting is changed (para. 22.1, 22.2), the setting of parameters 13.1 and 13.2 changes accordingly. Parameter 13.3 and 13.4 are not available with Macros PI- or PFC-Control.

9.1.4 Group 14 - Output Signals

These values can only be altered when SAMI GS is stopped.

Parameter	Range/Unit	Description
1 Analogue Out 1	Refer to the text below for the available selections	Analogue Output 1 content
2 Analogue Out 2		Analogue Output 2 content
3 Relay RO1 Out		Relay Output 1 content
4 Relay RO2 Out		Relay Output 2 content
5 Relay RO3 Out		Relay Output 3 content

1 Analogue Out 1

This parameter allows you to select which output signal is connected to Analogue Output 1 (current signal).

= Output frequency

= Motor speed

= Output current

= Motor torque

= Motor power

= DC-link voltage

= Motor voltage

SAMI GS

Additional selections available with the PFC Control Macro.

ERROR VAL = Scaled difference of ACT and REF values

PICON OUTP = PI-regulator output

ACTUAL 1 = Unscaled actual value 1

ACTUAL 2 = Unscaled actual value 2

PICON REF = Reference of PI regulator

2 Analogue Out 2

Refer to previous parameter.

3 Relay RO1 Out

This parameter allows you to select which information is indicated with Relay Output 1. Relay Output 1 is activated (according to the setting) if:

NOT USED

No relay activity wanted.

READY

The SAMI GS is ready to function.

RUN

The motor controller is active, and the motor is running.

FAULT

Any fault occurs. See Fault History (page 71) for more details.

FAULT (-1)

Reversed function of FAULT, i.e. the relay is normally activated and it releases on a fault. See fault messages Section 10.4.

STALL FLT

Stall protection has tripped.

MHEAT FLT

Motor overheat protection has tripped.

SAMI HEATF

SAMI overheat protection has tripped. The tripping level is 70°C (75°C for 050...060-3 and 060...070-5).

FAULT/WARN

Relay activated if any fault or warning occurs. See messages, Section 10.4.

WARNING

Relay is activated if any warning occurs. See warning messages, Section 10.4.

SAMI HEATW

The heatsink temperature has exceeded the warning level 65°C. (70°C).

REVERSED

Reverse is selected.

EXT. CTRL

External control selected.

REF2 SEL

Reference 2 selected.

CONST FREQ

A Constant Frequency (1-7) is selected.

Uc REG LIM

Voltage regulator is activated (by Motor Control software).

FREQ1 LIM

Output frequency has exceeded the supervision limit 1 (parameter 31.2).

FREQ2 LIM

Output frequency has exceeded the supervision limit 2 (parameter 31.4).

CUR LIM

Motor current has exceeded the set current limit (parameter 31.6).

REF1 LIM

Reference 1 has exceeded the set supervision limit (parameter 31.8).

REF2 LIM

Reference 2 has exceeded the set supervision limit (parameter 31.10).

4 Relay RO2 Out

This parameter allows you to select which information is indicated with Relay Output 2. Choices are identical as for para. 14.3 RELAY RO1 OUT.

5 Relay RO3 Out

This parameter allows you to select which information is indicated with Relay Output 3. Choices are identical as for para. 14.3 RELAY RO1 OUT.

Note! IF PFC Control Macro has been selected, the relevant relays for automatic exchange of motors will be reserved for this function only. The number of reserved relays depends on the number of aux. motors (para. 28.17). At least one relay will be reserved. Programming of reserved relays is not possible and the parameter value for these relays is:

PFC CTRL

9.1.5 Group 15 - Analogue Outputs

These values can be altered with the SAMI GS running.

Parameter	Range/Unit	Description
1 Filter AO1	0.01...10s	Filter time constant for AO1
2 Minimum AO1	0 mA/4 mA	Analogue Output signal 1 minimum
3 Invert AO1	No/Yes	Analogue Output signal 1 inversion
4 Filter AO2	0.01...10s	Filter time constant for AO2
5 Minimum AO2	0 mA/4 mA	Analogue Output signal 2 minimum
6 Invert AO2	No/Yes	Analogue Output signal 2 inversion

1 Filter AO1

Filter time constant for Analogue Output 1. 63 percent of the change of the Analogue Output value takes place within the time period given by this parameter. If you select the minimum value 0.01 s, the signal is not filtered (refer to Figure 9-2).

2 Minimum AO1

The minimum value of the Analogue Output signal can be set to either 0 mA or 4 mA.

3 Invert AO1

If you select YES, the Analogue Output 1 signal is inverted.

4 Filter AO2

5 Minimum AO2

6 Invert AO2

Refer to parameters 15.1 - 15.3.

9.1.6 Group 16 - Out Sig Scaling

These values can be altered with the SAMI GS running.

Parameter	Range/Unit	Description
1 Scale AO1	10...1000 %	Analogue Output signal 1 scaling factor
2 Scale AO2	10...1000 %	Analogue Output signal 2 scaling factor

1 Scale AO1, 2 Scale AO2

This parameter is the scaling factor for the Analogue Output 1 (2) signal. If you select 100 %, the nominal value of the output signal corresponds to 20 mA.

The nominal values for output signal Y are as follows:

- Frequency: 50 Hz
- Speed: motor speed at 50 Hz according to motor pole number
- Current: nominal current of motor (I_M)
- Power: nominal power of motor (P_M)
- Torque: nom. power of motor P_M /speed (motor data given in Start-Up Data)
- DC Voltage: DC voltage is $1.35 \cdot$ nominal supply voltage (U_N , Start up Data par. D).
- Mot. Volt.: U_N , Start up Data para. D

Note! If the output voltage is set higher than U_N (para. 27.2. > 1), the scaling factor should be < 100 % to reach max voltage with 20 mA.

With PFC macro the nominal values are:

Reference value, actual value 1, actual value 2, PI-Controller output = 100 % of scaled values.

Error value: +100 % = 20 mA; -100 % = 0 mA (4 mA). This means that 0 % correspond to 10 mA (12 mA).

If the desired value should be 20 mA, the scaling factor is calculated as follows:

$$X [\%] = 100 \% \cdot Y / Z$$

If the desired value should be < 20 mA, the scaling factor is calculated as follows:

a) Minimum output is 0 mA

$$X [\%] = 100 \% \cdot I_{AO} \cdot Y / (20 \text{ mA} \cdot Z)$$

b) Minimum output is 4 mA

$$X [\%] = 100 \% \cdot (I_{AO} - 4 \text{ mA}) \cdot Y / (16 \text{ mA} \cdot Z)$$

X [%] = scaling value

I_{AO} = desired output current 0(4) - 20 mA

Y = the nominal value in units of selected output signal

Z = the desired value in units of output signal which corresponds to I_{AO}

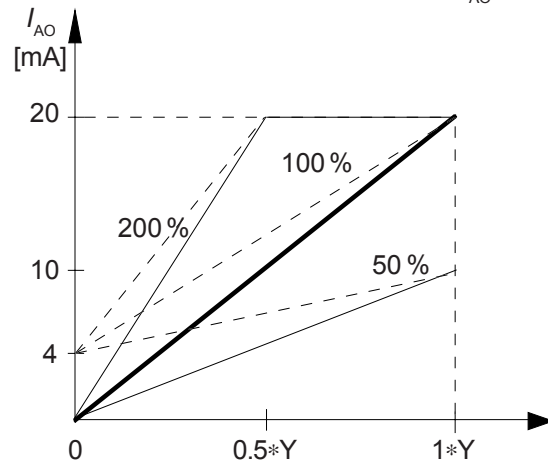

Figure 9-4. Scaling value.

9.1.7 Group 17 - Ext. Communication

These values can be altered with the SAMI GS running.

Parameter	Range/Unit	Description
1 SAMI ID Number	0 - 31	Identification of individual units connected to the serial link bus.
2 Bit Rate Select	1200, 2400, 4800, 9600 BIT/s	Speed of data transfer between the master and slave units.
3 Time-out Select	0.5 s - 100.0 s	The time which the SAMI GS waits for a response from a master before ending communication and giving a fault message.
4 Comms. fault funct	None, Fault, Fault+Stop	Type of message and operation when a fault occurs in communication between the master and a slave unit.
5 Bad messag counter	a number	Number of messages not accepted between the master and a slave unit.
6 Good mess counter	a number	Number of accepted messages between the master and a slave unit.

1 SAMI ID Number

Each SAMI GS connected to the RS 485 bus has to be identified with an ID number 1 to 31 when remote controlled. Each number can exist only once.

Number 0 disables remote control when physical connection has been made but remote control is not allowed.

2 Bit Rate Select

The bit rate can be set according to the device used to control connected units via the serial bus.

The bit rate may also depend on settings of the possible interface converter, which has to be used if a control device does not have an RS 485 communications port.

For the optional remote control panel SAGS 700 PAN the setting is 9600 bit/s.

3 Time-out Select

Minimum value which can be set depending on the number of connected units. It is recommended that this value is set as high as possible.

If very fast information on communication faults is needed, the value can be set lower. Too short a time-out setting may cause unnecessary time-out errors.

4 Comms. fault funct

The Mode of operation depends on the setting of this parameter when a fault has occurred in communications between the master and a slave unit:

NONE

The SAMI GS continues running with the last set parameter values and reference.

FAULT

The SAMI GS continues running and a fault message is displayed. If an output relay (RO1...RO3) is programmed as fault, this relay is activated.

FAULT+STOP

The SAMI GS stops and a fault message is displayed. If an output relay (RO1...RO3) is programmed as fault, this relay is activated.

Communication via RS 485 terminal

RS 485 serial communication is possible from an optional remote control panel SAGS 700 PAN or from a PC or a PLC.

PC and PLC applications require software utilising the protocol of the SAMI GS series. A maximum of 31 units can be connected into a bus. All units connected must have a different ID number (para. 17.1).

All functions of the SAMI GS standard control panel can be utilised via the serial bus:

- Start-up
- Parameter setting
- Monitoring and supervision
- Drive commands

Maximum control bus length depends on electromagnetic disturbances, cable size and cable screening.

Recommended max. cable length is 1200 m with 0.5 mm², 50 pF/m cable and 500 m with 0.2 mm², 50 pF/m cable. Maximum common mode voltage difference between terminals GND2 or GND3 of any units may not exceed ± 7 V. The cable is connected to the screw terminal X51 on the Control Interface Card, see Figures below.

Note! The last unit connected to the serial bus without any control device must be terminated by setting plugs S3 and S4 on the Control Interface Card to the position TERM.

For further information on RS 485 serial communication please refer to SAMI GS Bus protocol manual (order code: EN 5805782-7).

Connection of Remote Control Panel SAGS 700 PAN:

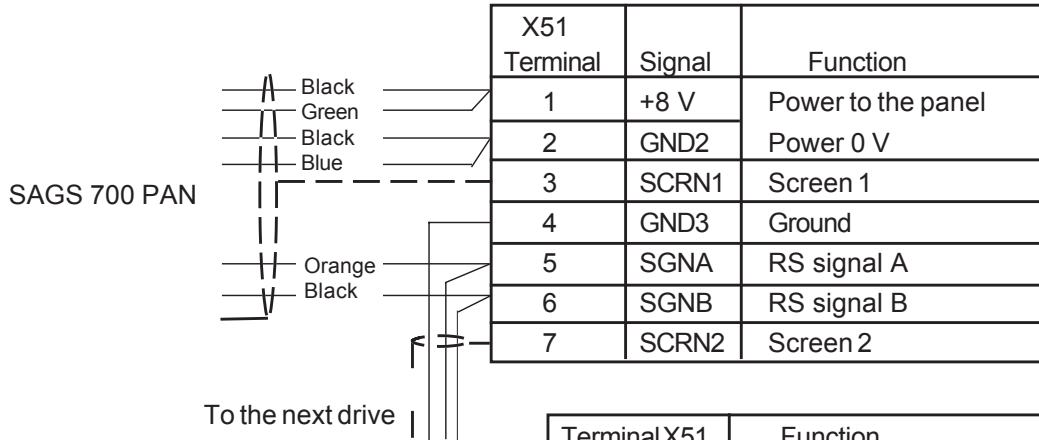

Example PC connection:

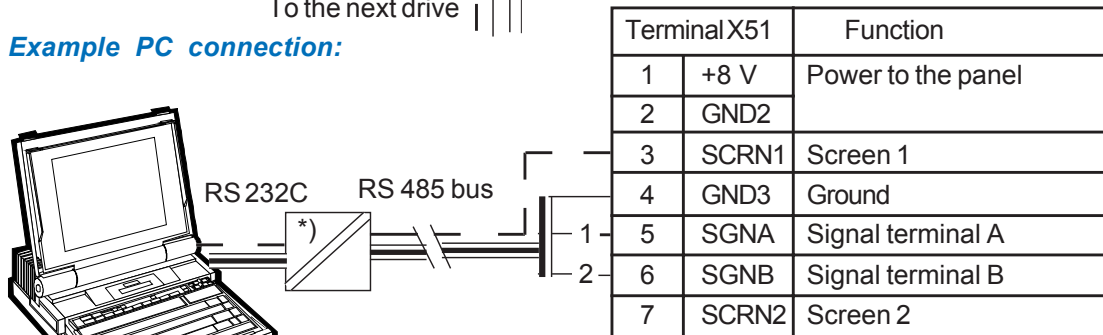

*) If the PC has an RS 232C serial communication port, a signal converter RS 232C/RS 485 is needed between the SAMI GS and the PC.

9.2 Main 20 - Drive

9.2.1 Group 21 - Acceler/Deceler

These values can be altered with the SAMI GS running.

Parameter	Range/Unit	Description
1 Acc/Dec Ramp Shape	Linear/S1...S3 Shape	Accel./Decel. ramp shape selection
2 Acceler Time 1	0.1...1800s	Time for $f_{\min} - f_{\max}$ acceleration ramp 1
3 Deceler Time 1	0.1...1800s	Time for $f_{\max} - f_{\min}$ deceleration ramp 1
4 Acceler Time 2	0.1...1800s	Time for $f_{\min} - f_{\max}$ acceleration ramp 2
5 Deceler Time 2	0.1...1800s	Time for $f_{\max} - f_{\min}$ deceleration ramp 2
6 Acceler Ref2 Time	0.1...1800s	Ref2 acceleration ramp time for 0 - 100 %
7 Deceler Ref2 Time	0.1...1800s	Ref2 deceleration ramp time for 100 - 0 %

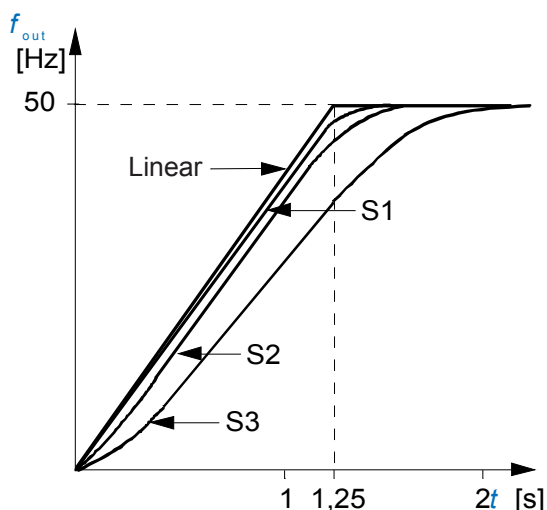

Figure 9-5. Acceleration/deceleration ramp shapes: Linear, S1, S2 and S3.

1 Acc/Dec Ramp Shape

This parameter allows you to select the shape of the acceleration/deceleration ramp. The available options are (refer to Figure 9-5):

LINEAR

Suitable for drives requiring steady acceleration/deceleration and/or slow ramps.

S1-SHAPE

Suitable for ramp times less than one second.

S2-SHAPE

Suitable for ramp times less than 1.5 seconds.

S3-SHAPE

Suitable for ramp times up to 15 seconds.

2 Acceler Time 1, 3 Deceler Time 1

4 Acceler Time 2, 5 Deceler Time 2

These times correspond to the time required for the output frequency to change from MINIMUM to MAXIMUM FREQUENCY and vice versa. Regardless of the settings, the maximum theoretical acceleration/deceleration is $120\text{Hz}/0.1\text{s}$ (max slope = 1200Hz/s) and the minimum $120\text{Hz}/1800\text{s}$ (min slope = 0.067Hz/s). The time required for the acceleration from zero to minimum frequency depends on the ACCELER TIME (acceleration = $f_{\max} - f_{\min}/\text{acceleration time}$).

Note! The SAMI GS incorporates a bus controller that prevents overcurrent and overvoltage trips caused by too fast acceleration and deceleration for a given system (by increasing the acceleration/ deceleration settings).

If a small number is entered for the acceleration time in a system with high inertia, the acceleration time will be limited by the OUTPUT CURRENT (parameter 22.3). Conversely, if a small number is entered for deceleration time in such a system, the deceleration time will be limited by the DC link bus regulator. In some cases, the motor will take a long time to come to a stop. If a short deceleration time is critical to your application, we suggest you add a dynamic braking device to your system.

The maximum (minimum) recommended acceleration (deceleration) for the nominal size motor is 40 Hz in 1 second. If the motor rating is less than the nominal power of the SAMI GS, smaller settings can be used.

If the reference signal changes more slowly than the acceleration or deceleration time, the output frequency change will follow the reference signal. If the reference signal changes faster than the acceleration or deceleration time, the output frequency change will be limited by the parameters.

6 Acceler Ref2 Time
7 Deceler Ref2 Time

These times correspond to the time required for the reference to change from 0 to 100 % and vice versa.

9.2.2 Group 22 - Freq/Cur Limits

These values can be altered with the SAMI GS running.

Parameter	Range/Unit	Description
1 Minimum Frequency	0...120/500 Hz*)	Minimum operating frequency (f_{min})
2 Maximum Frequency	0...120/500 Hz*)	Maximum operating frequency (f_{max})
3 Output Current	0.5...2.0* I_N [A]	Output current limit
4 Max. Freq. Range	0 - 120 Hz/0 - 500 Hz*)	Normal/Extended Range for ACS 501

*) Max value is set automatically according to the setting of parameter 22.4.

1 Minimum Frequency
2 Maximum Frequency

The MINIMUM FREQUENCY represents the minimum output frequency available. In a similar fashion, the MAXIMUM FREQUENCY is the maximum output frequency available (see para. 13.1 and 13.2).

3 Output Current

This setting determines the max.output current the SAMI GS will supply to the motor. If the rated current of the motor is lower than the rated current of the SAMI GS, the current limit is recommended to be set in accordance with the motor rating in standard applications.

Note! Current limitation time is not supervised. Excessive overcurrent may cause SAMI to stop the drive due to overtemperature.

Note! If a value greater than 1.5 is entered, the SAMI will automatically decrease the limit to 1.5 when the output frequency is higher than 0.74* FIELD WEAK POINT.

4 Max. freq. Range

This Parameter extends the setting range of parameter 22.1/22.2/13.1 to 13.4/23.2 to 23.11/24.1 to 24.7/28.7/28.9 to 28.14/31.2/31.4 and 31.8.

9.2.3 Group 23 - Crit Frequencies

These values can be altered with the SAMI running.

Parameter	Range / Unit	Description
1 Crit Freq Select	Off/On	Critical frequency jump over logic
2 Crit Freq 1 Low	0...120/500 Hz*)	Critical frequency 1 start
3 Crit Freq 1 High	0...120/500 Hz*)	Critical frequency 1 end
4 Crit Freq 2 Low	0...120/500 Hz*)	Critical frequency 2 start
5 Crit Freq 2 High	0...120/500 Hz*)	Critical frequency 2 end
6 Crit Freq 3 Low	0...120/500 Hz*)	Critical frequency 3 start
7 Crit Freq 3 High	0...120/500 Hz*)	Critical frequency 3 end
8 Crit Freq 4 Low	0...120/500 Hz*)	Critical frequency 4 start
9 Crit Freq 4 High	0...120/500 Hz*)	Critical frequency 4 end
10 Crit Freq 5 Low	0...120/500 Hz*)	Critical frequency 5 start
11 Crit Freq 5 High	0...120/500 Hz*)	Critical frequency 5 end

*) Max value is set automatically according to the setting of parameter 22.4.

In some systems it may be necessary to avoid some frequencies because of resonance problems. With this Group it is possible to set up five different frequency ranges which the frequency converter will skip. It is not necessary that, for example, 4 CRIT FREQ 2 LOW be greater than 3 CRIT FREQ 1 HIGH, providing the LOW parameter of any one set is lower than the HIGH parameter of the same set. Sets may overlap, but the skip will be from the lower LOW value to the higher HIGH value.

The Critical Frequency settings are activated with parameter 1 CRIT FREQ SELECT (Yes).

Example: A fan system has severe vibration problems from 18 Hz to 23 Hz and from 46 Hz to 52 Hz. The speed reference is set to 60 Hz. Set the parameters as follows (set the "HIGH" value first before setting the "LOW" value):

2 CRIT FREQ 1 LOW	18 Hz
3 CRIT FREQ 1 HIGH	23 Hz
4 CRIT FREQ 2 LOW	46 Hz
5 CRIT FREQ 2 HIGH	52 Hz

If, due to e.g. bearing wear, another resonance occurs at 34 - 36 Hz, the critical frequency table can be added to as follows:

6 CRIT FREQ 3 LOW	34 Hz
7 CRIT FREQ 3 HIGH	36 Hz

Note! Scale the range to 0 Hz for those Critical frequencies which are not used.

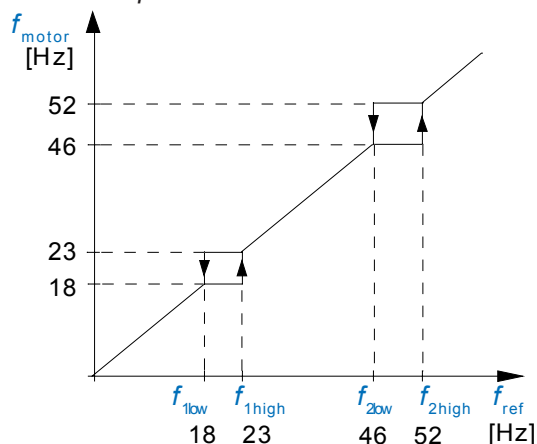

Figure 9-6. Example of Critical Frequencies settings in a fan system with vibration problems at the frequency ranges 18 Hz - 23 Hz and 46 Hz - 52 Hz.

9.2.4 Group 24 - Const Frequencies

These values can be altered with the SAMI GS running.

Parameter	Range/Unit	Description
1 Const Frequency 1	0...120/500 Hz*)	Override frequency 1
2 Const Frequency 2	0...120/500 Hz*)	Override frequency 2
3 Const Frequency 3	0...120/500 Hz*)	Override frequency 3
4 Const Frequency 4	0...120/500 Hz*)	Override frequency 4
5 Const Frequency 5	0...120/500 Hz*)	Override frequency 5
6 Const Frequency 6	0...120/500 Hz*)	Override frequency 6
7 Const Frequency 7	0...120/500 Hz*)	Override frequency 7/Jog (Par. 32.1)

*) Max value is set automatically according to the setting of parameter 22.4.

Constant Frequencies override any other reference, when in External Control mode. Constant Frequencies are activated with Digital Input(s) according to parameter 11.7 CONST SPEED SEL.

Note! CONST FREQUENCY 7 is a jog frequency, which may be activated in case of serial communication fault. Refer to parameter 32.1.

9.2.5 Group 25 - PI-Controller

These values can be altered with the SAMI GS running except those marked with (O). The parameters of this group will be available only when parameter B APPLICATIONS of the START-UP DATA group has been set to PI-CONTROL, see chapter 8.4.

Parameter	Range/Unit	Description
1 PI-Cont Gain	3...800 %	PI-Controller Gain selection
2 PI-Cont I-Time	0.02...320.00 s	PI-Controller I-time selection
3 PI-Cont Min Lim	0... 120/500 Hz *)	PI-Controller output freq. minimum limit
4 PI-Cont Max Lim	0... 120/500 Hz *)	PI-Controller output freq. maximum limit
5 Error Value Inv	No/Yes	PI-Controller error value inversion
6 Actual Value Sel (O)	Act1/Act1-Act2/ Act1+Act2/Act1*Act2	PI-Controller Actual signal selection
7 Actual 1 Input (O)	No/AI1/AI2/Std Commu	Actual 1 signal input selection
8 Actual 2 Input (O)	No/AI1/AI2	Actual 2 signal input selection
9 Actual 1 Min Scale	-1600.0...1600.0 %	Minimum scaling factor for act. 1 signal
10 Actual 1 Max Scale	-1600.0...1600.0 %	Maximum scaling factor for act. 1 signal
11 Actual 2 Min Scale	-1600.0...1600.0 %	Minimum scaling factor for act. 2 signal
12 Actual 2 Max Scale	-1600.0...1600.0 %	Maximum scaling factor for act. 2 signal

*) Max value is set automatically according to the setting of parameter 22.4.

1 PI-Cont Gain

This parameter defines the gain of the PI-Controller included in the Application Macros of the SAMI GS. Setting range is 3...800 %. If you select 100 %, a 10 % change in error value causes the controller output to change by 1.5 Hz.

If the parameter value is set to 3.0 %, the PI-Controller operates as an I-Controller.

2 PI-Cont I-Time

If the parameter value is set to 320.00 s, the PI-Controller operates as a P-Controller.

How to start up the PI-Controller

To start the PI-controller it is useful to measure the motor frequency and reference it to the PI-controller (Ref 2). This can be done by setting the parameter 14.1 and 14.2 accordingly.

First the PI-CONT I-TIME is set to 320 s to operate with a P-Controller. The PI-CONT GAIN is set to a small value (e.g. default value 100%). With small reference steps (1 %) the response (motor frequency) is monitored. The PI-CONT-GAIN is increased until the drive ceases to be overcompensated (see Figure 9-7). This should be done within the whole speed range (approx. 100 rpm steps). Finally the reference steps are increased to suitable values for this application.

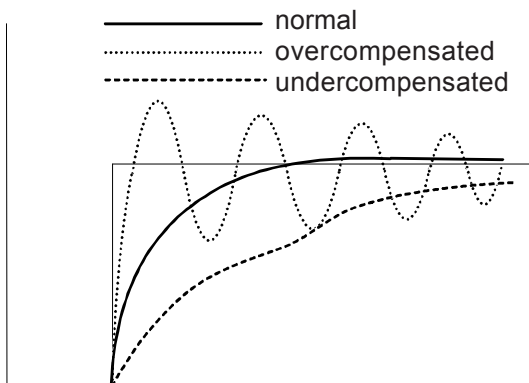

Figure 9-7. Frequency response to reference step with P-Controller.

For operation with PI-Controller the value for PI-CONT GAIN, determined by the operation as P-controller, is divided by 2 and put to para. 25.1. The PI-CONT I-TIME is set to a low value e.g. 10 s. The drive response (motor frequency) to small reference steps is monitored. The PI-CONT-I-TIME is increased until overshoot is observed. This should be done within the whole speed range and with reference steps suitable for this application until drive response overshooting is within acceptable range.

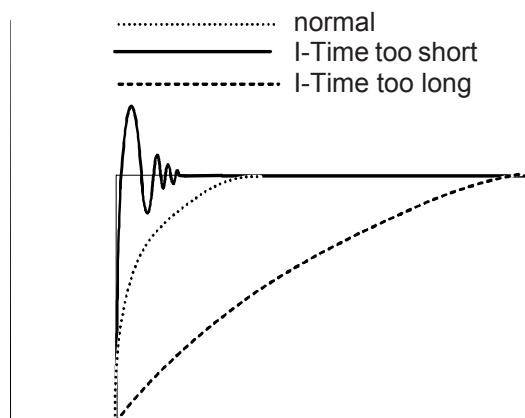

Figure 9-8. Frequency response to reference step with PI-Controller.

PI-Controller fine tuning can be done by small changes of the above determined values.

3 PI-Cont Min Lim

The minimum value of the PI-Controller frequency output. The limit cannot be set less than para. 22.1 MINIMUM FREQUENCY.

4 PI-Cont Max Lim

The maximum value of the PI-Controller frequency output. The limit cannot be set greater than para. 22.2 MAXIMUM FREQUENCY.

5 Error Value Inv

This parameter allows you to invert the Error Value (and thus the operation of the PI-Controller).

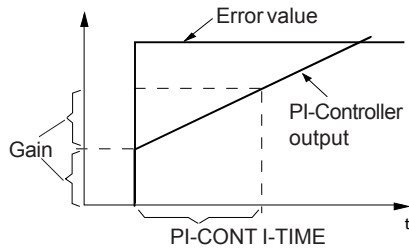

Figure 9-9. PI-Controller.

6 Actual value selection

This parameter defines how the feedback for the PI-Controller is calculated. Two analogue values (Act1 and Act2) can be subtracted, added or multiplied; also Act1 can be selected on its own.

7 Actual 1 Input, 8 Actual 2 Input

This parameter selects the input terminal for Act1 (Act2).

9 Act1 min Scale, 10 Act1 max Scale

11 Act2 min Scale, 12 Act2 max Scale

Actual value signals can be scaled to correspond to the required regulation range with the minimum and maximum value scaling parameters.

Scaling values can be determined using the nomogram in figure 9-11 and the formulae as stated below.

Range of the reference value ($\Delta Y0$) and the actual value ($\Delta X0$) in units (V, mA):

$$\Delta Y0 = Y0_{max} - Y0_{min}$$

$$\Delta X0 = X0_{max} - X0_{min}$$

With the minimum and maximum values of the reference span ($Y1_{min}, Y1_{max}$) and the actual span ($X1_{min}, X1_{max}$) in units (V, mA) the values are transformed to percentages:

$$Y1'_{min} = [(Y1_{min} - Y0_{min}) / \Delta Y0] * 100 \%$$

$$Y1'_{max} = [(Y1_{max} - Y0_{min}) / \Delta Y0] * 100 \%$$

$$X1'_{min} = [(X1_{min} - X0_{min}) / \Delta X0] * 100 \%$$

$$X1'_{max} = [(X1_{max} - X0_{min}) / \Delta X0] * 100 \%$$

Span of the reference value ($\Delta Y1'$) and the actual value ($\Delta X1'$) as a percentage:

$$\Delta Y1' = Y1'_{max} - Y1'_{min}$$

$$\Delta X1' = X1'_{max} - X1'_{min}$$

Calculation of the maximum actual value (Xs'_{max}) and the minimum actual values as a percentage (Xs'_{min}) of full reference scale ($Y0'=100\%, Y0'=0\%$):

ACT1(2)MAX SCALE:

$$Xs'_{max} = X1'_{max} + (100\% - Y1'_{max}) * \Delta X1' / \Delta Y1'$$

ACT1(2)MIN SCALE:

$$Xs'_{min} = X1'_{min} + (0\% - Y1'_{min}) * \Delta X1' / \Delta Y1'$$

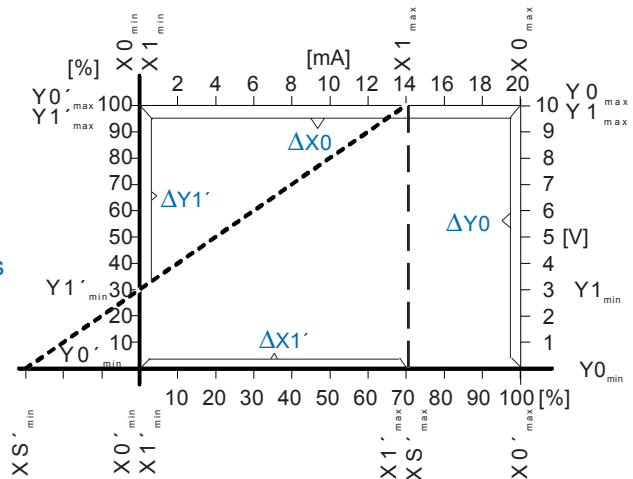

Figure 9-10. Basics of scaling factors.

Example:

The pressure of a pipe system is to be controlled between 0 and 10 bar.
 Pressure transducer for 0 to 10 bar with output span 3 to 9 V, output range 2 to 10 V.
 Reference signal is 4 to 20 mA, where 6.4 mA = 0 bar and 16 mA = 10 bar.

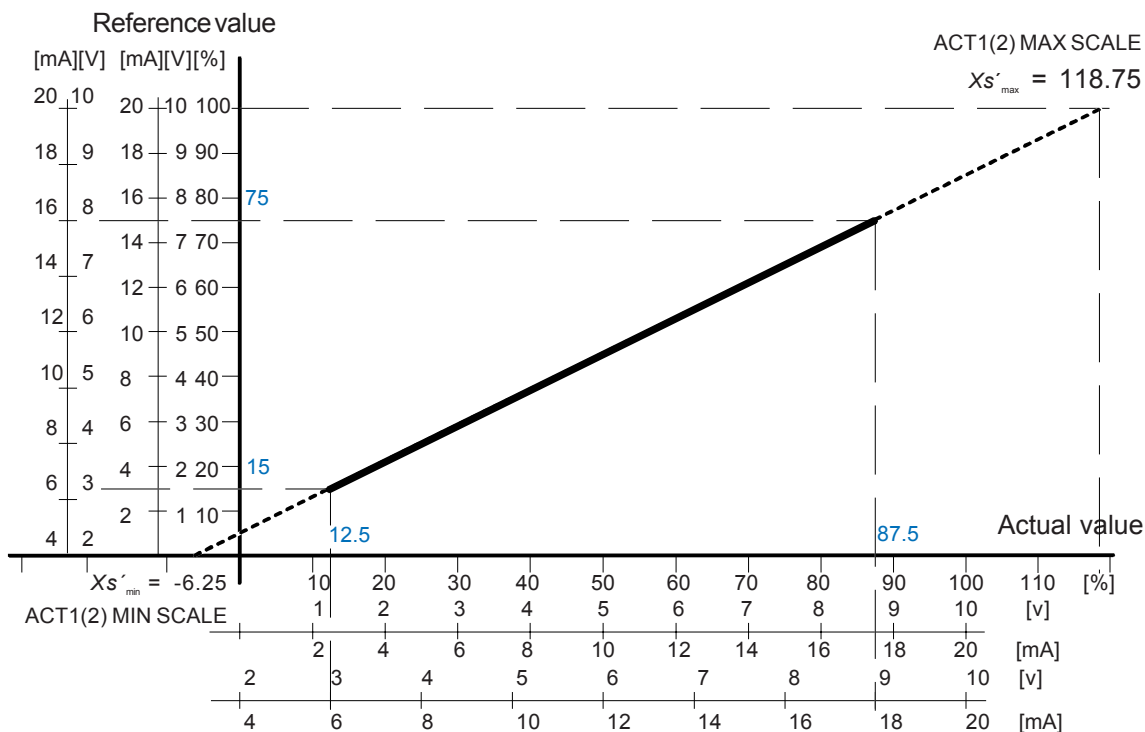

Figure 9-11. Scaling of actual value.

$$\Delta Y0 = Y0_{max} - Y0_{min} = 20 - 4 = 16 \text{ mA}$$

$$\Delta X0 = X0_{max} - X0_{min} = 10 - 2 = 8 \text{ V}$$

$$Y1'_{min} = [(Y1_{min} - Y0_{min}) / \Delta Y0] * 100 \% = [(6.4 - 4) / 16] * 100 \% = 15 \%$$

$$Y1'_{max} = [(Y1_{max} - Y0_{min}) / \Delta Y0] * 100 \% = [(16 - 4) / 16] * 100 \% = 75 \%$$

$$X1'_{min} = [(X1_{min} - X0_{min}) / \Delta X0] * 100 \% = [(3 - 2) / 8] * 100 \% = 12.5 \%$$

$$X1'_{max} = [(X1_{max} - X0_{min}) / \Delta X0] * 100 \% = [(9 - 2) / 8] * 100 \% = 87.5 \%$$

$$\Delta Y1' = Y1'_{max} - Y1'_{min} = 75 - 15 = 60 \%$$

$$\Delta X1' = X1'_{max} - X1'_{min} = 87.5 - 12.5 = 75 \%$$

$$Xs'_{max} = X1'_{max} + (100 \% - Y1'_{max}) * \Delta X1' / \Delta Y1' = 87.5 + (100 - 75) * 75 / 60 = 118.75 \%$$

$$Xs'_{min} = X1'_{min} + (0 \% - Y1'_{min}) * \Delta X1' / \Delta Y1' = 12.5 + (0 - 15) * 75 / 60 = -6.25 \%$$

$$\text{ACT1(2) MAX SCALE} = 118.8 \%$$

$$\text{ACT1(2) MIN SCALE} = -6.3 \%$$

The Result has been drawn in Figure 9-11 above.

9.2.6 Group 26 - Start/Stop

These values can only be altered when the SAMI GS is stopped except those marked with (I).

Parameter	Range/Unit	Description
1 StartFunction	Ramp/Flying/Torq Boost/Flying+TQB	Conditions during motor acceleration
2 Torque Boost Cur	0.5...2.0 * I_N [A]	Torque Boost current level selection
3 Stop Function (I)	Coast/Ramp/DC-Brake	Conditions during motor deceleration
4 Brake Chopper (I)	No/Yes	Dynamic Braking Device activation
5 DC Holding	Off/On	Enable DC Holding
6 DC-Hold Voltage	0.01...0.1 * U_N [V]	Voltage set for DC Holding
7 DC-Brake Voltage	0.01...0.1 * U_N [V]	Voltage set for DC injection braking
8 DC-Brake Time	0...250s	Duration of DC injection braking

1 Start Function

This parameter determines how the SAMI will start.

RAMP

Ramp acceleration as set in Group 21.

FLYING

Use this setting to start the motor if it is already rotating, such as in a fan drive. The drive will start smoothly at the present frequency instead of starting at 0 Hz. Selecting FLYING ensures the drive will ride through short interruptions of the mains supply.

Note! Flying start searches for the running speed by applying a small torque to the load at the MAXIMUM FREQUENCY and decreasing the output frequency until the load speed is found. If the motor is not coupled to a load or the load has low inertia, the shaft speed will follow this search program. Flying start doesn't work properly if several motors are connected to the SAMIGS.

TORQ BOOST

Automatic start current boost, which may be necessary in drives with high starting torque. Allows using start current higher than the limit set with para. 22.3. Automatic torque boost is active only from 0 Hz to 20 Hz or until the reference speed is reached. Torque boost is not activated if the output frequency falls below 20 Hz while running.

See also IR COMPENSATION in Group 27.

FLYING + TQB

Both Flying Start and Torque Boost functions are active.

2 Torque Boost Cur

The current level used in Torque boost is set by this parameter. Keep the boost current as low as possible for the application.

3 Stop Function

This parameter determines how the SAMI will stop the drive.

COAST

The frequency converter ceases to supply voltage and the motor coasts to a stop.

RAMP

Ramp deceleration as set in Group 21.



Note! If the drive is stopped by the RUN ENABLE signal, the SAMI GS will stop by coasting regardless of the STOP FUNCTION setting.

DC BRAKE

DC injection braking stops the motor by applying DC-voltage to the stator windings. By using DC braking, the motor can be stopped in the shortest possible time, without the use of a dynamic braking device.

4 Braking Chopper

If a dynamic braking device is used, the braking torque can be increased by setting this parameter to YES.

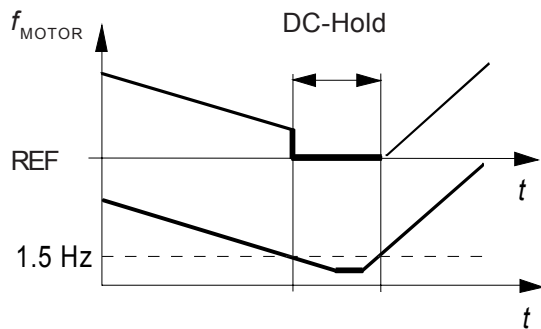

Figure 9-12 DC Holding.

5 DC Holding

If this parameter is set to YES, the DC HOLDING feature is enabled.

When both reference and output frequencies drop below 1.5 Hz, the frequency converter will stop generating rotating waveforms and inject a DC-voltage to the motor. The voltage value is set with the DC-HOLD VOLTAGE. When the reference frequency goes above 1.5 Hz, the DC-voltage will be removed and the frequency converter resumes normal operation.

DC Holding has no effect when the START signal is deactivated.

Note! Injecting DC voltage into the motor may cause motor overheating. In applications where long DC-Holding times are required, ensure the DC-HOLD VOLTAGE is set at a low value, avoiding motor overheating due to high motor current. During long DC-Hold periods the DC Hold function cannot prevent the motor shaft rotating, when a constant load is applied to the motor.

7 DC-Brake Voltage

When the stop function (para. 26.3) is set to DC BRAKE, this parameter sets the DC-voltage injected into the motor. The factory setting is suitable for a nominal size motor. If braking is too effective, decrease this value. If braking is not sufficient, increase this value.

8 DC-Brake Time

When the stop function is set to DC BRAKE, this parameter sets the DC injection time in seconds. If the braking time is too short, the drive stops by coasting once the DC-BRAKE TIME has elapsed.

9.2.7 Group 27 - Motor Control

These values can only be altered when the SAMI GS is stopped, except those marked with (I).

Parameter	Range/Unit	Description
1 Switching Freq	1.0 - 12.0 kHz	Modulator frequency
2 SAMI Max Out Volt	0.15...1.05* U_N [V]	Maximum motor voltage selection
3 Motor Power	Rated/<Rated/>Rated	$I_{N,motor}/I_{N,SAMI}$ -ratio for Motor Controller
4 U/f Ratio	Linear/Squared/ Automatic	Voltage to frequency relationship in region below Field Weakening Point
5 Field Weak Point	30...500 Hz	Threshold for nominal voltage
6 IR Compensation	No/Manual/Automatic	Low speed torque boost function
7 IR-Comp Voltage	0.01...0.15* U_N [V]	Voltage level in manual IR Compensation
8 IR-Comp Range	0...FWP [Hz]	Zero point in manual IR Compensation
9 Slip Compensation (I)	Off/On	Automatic slip reduction
10 Nominal Slip (I)	0.1...10%	Nominal slip of the motor
11 O/U Volt Control (I)	Off/On	Over-/Undervoltage Controller

1 Switching Freq

Motor noise can be minimised by adjusting the switching frequency to a value that does not create resonances in the motor system. The optimum switching frequency is the lowest frequency at which noise is acceptable. This frequency may not be the same for identical motor systems.

As switching frequency increases, inverter efficiency goes down (refer to Figure 4-1. on page 12), so it is best to use a low switching frequency if the application can tolerate noise.

2 SAMI Max Out Volt

This parameter sets the maximum output voltage (fundamental) of the SAMI.

3 Motor Power

To ensure accurate operation of the Motor Control Card, it is important to indicate whether the nominal current of the motor is the same (RATED $\pm 20\%$), lower (<RATED)

or higher (>RATED) than the nominal current of the SAMI.

4 U/f Ratio

LINEAR

The voltage of the motor changes linearly with frequency in the constant flux area. Linear U/f ratio is normally used where the load's torque characteristics is linear with speed (refer to Figure 9-13).

SQUARED

The voltage of the motor is maintained in the constant flux area less than in the case of Linear U/f. The motor is undermagnetised so noise and motor losses are reduced. Squared U/f ratio is normally used in applications where the load torque characteristic is proportional to the square of the speed, such as centrifugal pump and fan drives.

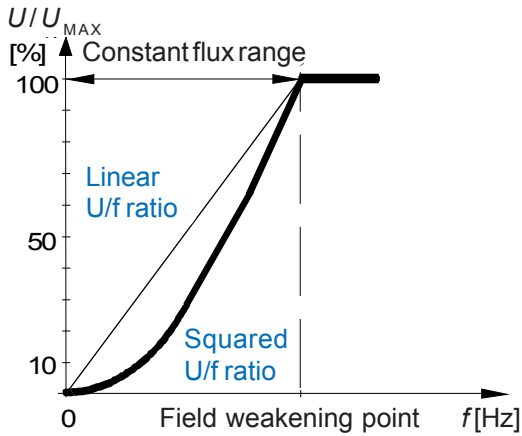

Figure 9-13. The voltage to frequency ratio in the frequency range 0 Hz to the field weakening point can be set to either LINEAR, SQUARED or AUTOMATIC.

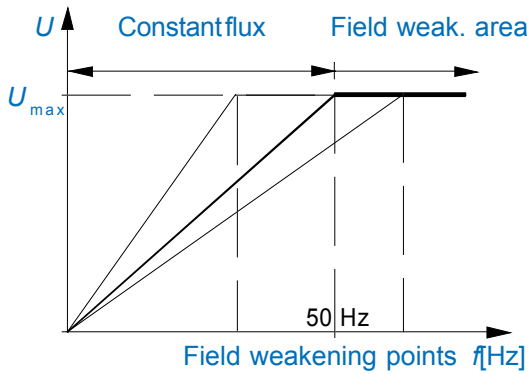

Figure 9-14. Field weakening point.

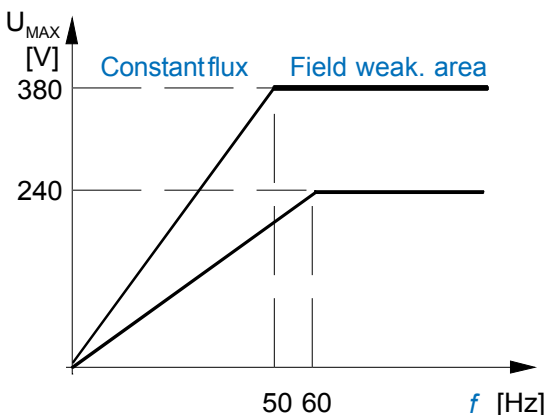

Figure 9-15. By adjusting the field weakening point and SAMI MAX OUT VOLT, motors other than those of rated voltage can be used.

AUTOMATIC

The motor voltage is automatically controlled to minimise motor losses and noise. This setting is suitable for a drive which has a slowly changing load torque and a motor that operates mainly below nominal load.

Note! If SQUARED or AUTOMATIC is selected, then para. 27.6 IR COMPENSATION should not be set to AUTOMATIC.

5 Field Weak Point

The Field Weakening Point is the frequency at which the output voltage reaches the maximum motor voltage (para. 27.2). Above this frequency, the voltage remains at the set maximum value (U_{MAX}). Also see Figure 9-15.

6 IR Compensation

This parameter allows extra torque at speeds between 0.1 Hz and the set field weakening point. The parameter differs from the TORQ BOOST option of the START FUNCTION in that it is always valid in the above mentioned speed range.

NO

No compensation wanted.

MANUAL

The compensation voltage and range are given by the user (parameters 7 and 8 in this Group).

AUTOMATIC

The IR-Compensation voltage is automatically controlled as a function of effective motor current. This setting is suitable when the need for IR Compensation changes and manual control of the Compensation voltage is difficult.

Note! If AUTOMATIC is selected, then LINEAR should be selected in para. 27.4 U/F RATIO.

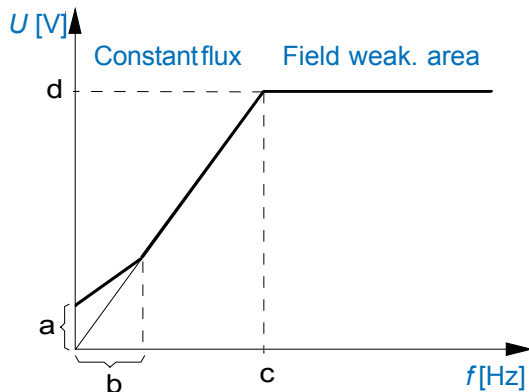

Figure 9-16. IR COMPENSATION is implemented by applying extra voltage to the motor.

a=IR-COMP VOLTAGE
b=IR-COMP RANGE
c=FIELD WEAKENING POINT
d=SAMI MAX OUT VOLT

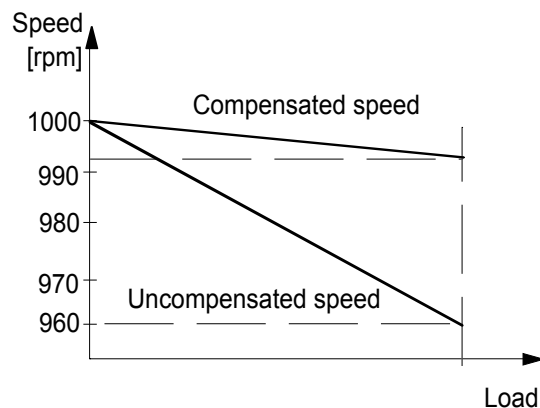

Figure 9-17. Slip compensation reduces slip under load (Example: 6-pole motor).

7 IR-Comp Voltage

The compensation voltage level in MANUAL IR COMPENSATION. Keep the boost voltage as low as possible for the application, as the motor will overheat rapidly or an overcurrent fault may occur when a high level of compensation is applied.

Small motors can take higher compensation than larger motors because the winding resistance is higher. If the load torque is high, use just enough IR-compensation to drive the load.

8 IR-Comp Range

This parameter defines the frequency at which the Manual IR COMPENSATION reduces to zero. The compensation voltage reduces linearly with increasing frequency.

9 Slip Compensation

A squirrel-cage motor will slip under load. This slip can be compensated by increasing the frequency as the current increases. By setting this parameter to ON, slip is reduced to approximately 10 % of the original value. If you require exceptionally precise speed control, you may want to use a frequency controller with tachometer feed-back control. Contact your local SAMI representative for more information.

10 Nominal Slip

For the precise operation of the Slip Compensation function, it is necessary for the SAMI to know the nominal slip of the motor. Nominal slip is given as a percentage of the synchronous speed.

Nominal slip of the motor s_N [%] can be derived from synchronous speed n_s and nominal speed n_N :

$$s_N = 100\% * (n_s - n_N)/n_s$$

11 O/U Volt Control

This parameter allows you to turn off the Over-/Undervoltage Controller. This may be useful for example, if the supply network voltage varies more than $\pm 10\%$ and the application will not tolerate the O/U Controller controlling the output frequency in accordance with the supply voltage. (An under-/overvoltage trip may occur, instead).

9.2.8 Group 28 - PFC Control

These values can be altered with the SAMI GS running except those marked with (O). The Parameters of this group will be available only when parameter B APPLICATIONS of the START-UP DATA group has been set to PFC CTRL, see Section 8.4.

Parameter	Range/Unit	Description
1 PI-Cont Gain	3...800.0%	PI-Controller Gain selection
2 PI-Cont I-Time	0.1...320s	PI-Controller I-time selection
3 Reference Step 1	0...100.0%	Reference step when the first aux. motor is started (in % of actual value)
4 Reference Step 2	0...100.0%	Reference step when the second aux. motor is started (in % of actual value)
5 Reference Step 3	0...100.0%	Reference step when the third aux. motor is started (in % of actual value)
6 Sleep Delay	0...3600s	Delay time for switch off with sleep function
7 Sleep Level	0...120/500 Hz*)	Frequency value to stop SAMI GS with sleep function
8 Wake Up Level	0...100.0%	Actual value for restarting when sleep function is active (in % of scaled actual value)
9 Start Freq 1	0...120/500 Hz*)	Output frequency at which the first aux. motor will start. The start frequency has a fixed 1 Hz hysteresis.
10 Start Freq 2	0...120/500 Hz*)	Output frequency at which the second aux. motor will start. The start frequency has a fixed 1 Hz hysteresis.
11 Start Freq 3	0...120/500 Hz*)	Output frequency at which the third aux. motor will start. The start frequency has a fixed 1 Hz hysteresis.
12 Low Freq 1	0...120/500 Hz*)	Frequency level for stopping the first aux. motor
13 Low Freq 2	0...120/500 Hz*)	Frequency level for stopping the second aux. motor
14 Low Freq 3	0...120/500 Hz*)	Frequency level for stopping the third aux. motor
15 Aux Mot Start DLY	0...3600s	Start delay for the auxiliary motors
16 Aux Mot Stop DLY	0...3600s	Stop delay for the auxiliary motors
17 NBR of Aux Motors	0...3	Number of auxiliary motors
18 Autochange Interv.	0 min...168h	Elapsed time for automatic exchange of connected motors

SAMI GS

Parameter	Range/Unit	Description
19 Autochange Level(O)	0...100.0%	Actual value level for automatic exchange of connected aux. motors
20 Interlocks (O)	On/Off	Enables/disables the interlocking function of aux. motors
21 Error Value Inv (O)	No/Yes	Determines whether or not the PI-Controller error signal is inverted
22 Actual 1 Input(O)	No/AI1-AI4/ Std Commu	Actual 1 signal input selection
23 Actual 2 Input(O)	No/AI1-AI4	Actual 2 signal input selection
24 Actual Value Sel(O)	f(ACT1, ACT2)	PFC Controller actual value selection
25 ACT1 Min Scale	-1600%...+1600 %	Minimum scaling factor for actual 1 signal
26 ACT1 Max Scale	-1600%...+1600 %	Maximum scaling factor for actual 1 signal
27 ACT2 Min Scale	-1600%...+1600 %	Minimum scaling factor for actual 2 signal
28 ACT2 Max Scale	-1600%...+1600 %	Maximum scaling factor for actual 2 signal
29 Regul Bypass Ctrl	No/Yes	Bypass selection of the PI-Controller
30 Display Unit	No/[Unit]	Selection of unit for ACT1 and ACT2
31 Displ Unit Scale	0...50000	Scaling factor for display unit
32 NBR of Decimals	0...5	Number of decimal digits of the displayed actual values.

*) Max value is automatically set according to the setting of parameter 22.4.

1 PI-Cont Gain,

2 PI-Cont I-Time

See description PI-Control Section 9.2.5

3 Reference Step 1,

4 Reference Step 2,

5 Reference Step 3

Reference value increase after start of the first (second, third) aux. motor, e.g. in pump applications with two (or more) pumps, the reference value of the regulated pump can be increased with this parameter to correspond to the increased system pressure.

6 Sleep Delay

If the output frequency remains below the sleep level frequency (parameter 28.7) longer than the sleep delay set with this parameter, the SAMI GS is stopped automatically. If the sleep delay is set to 0 s, the sleep function is disabled.

7 Sleep Level

If the output frequency remains below the frequency set with this parameter longer than the sleep delay (parameter 28.6) the SAMI GS stops automatically. The PFC Function supervises actual value changes and re-starts the SAMI GS when the wake-up level (para. 28.8) is exceeded.

8 Wake Up Level

Level is a percentage of the set reference range. This parameter determines the level of the actual value at which the SAMI GS will restart. If the reference value is set below the

set wake-up level while the sleep function is active, the SAMI GS will restart when the actual value goes below the new set reference value as shown in Figure 9-18 below.

Note! Wake-up level is calculated from the scaled actual value. For example, with 4 to 5 bar scaled actual value range a 10 % wake-up level corresponds to 4.1 bar.

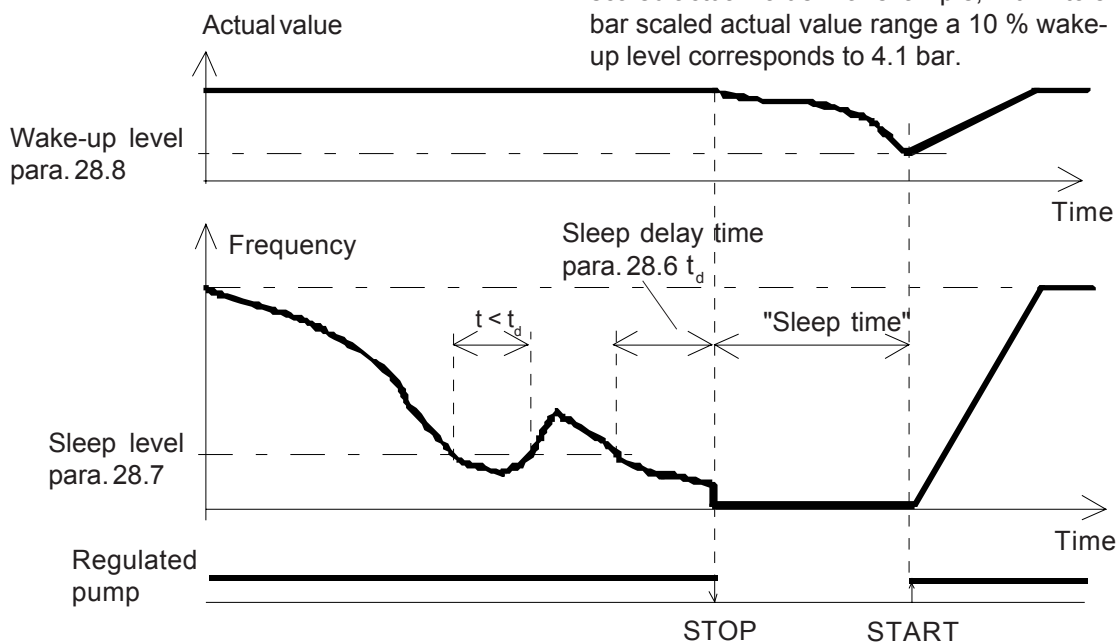

Figure 9-18. Example of the sleep function.

9 Start Freq 1

10 Start Freq 2

11 Start Freq 3

Output frequency at which the first (second, third) auxiliary motor will start. The start frequency has a fixed 1 Hz hysteresis.

12 Low Freq 1

13 Low Freq 2

14 Low Freq 3

Minimum frequency to the regulated motor after start of the first (second, third) auxiliary motor. If the output frequency goes below this limit by 1 Hz, the auxiliary motor will stop.

15 Aux Mot Start DLY

Start delay of auxiliary motors to prevent starting at a momentary crossing of the start limit, e.g. due to pressure impacts in water supply systems.

16 Aux Mot Stop DLY

Stop delay of the aux. motors to prevent stopping at a momentary crossing of the stop limit, e.g. due to pressure impacts in water supply systems.

17 NBR of Aux Motors

Number of auxiliary motors.

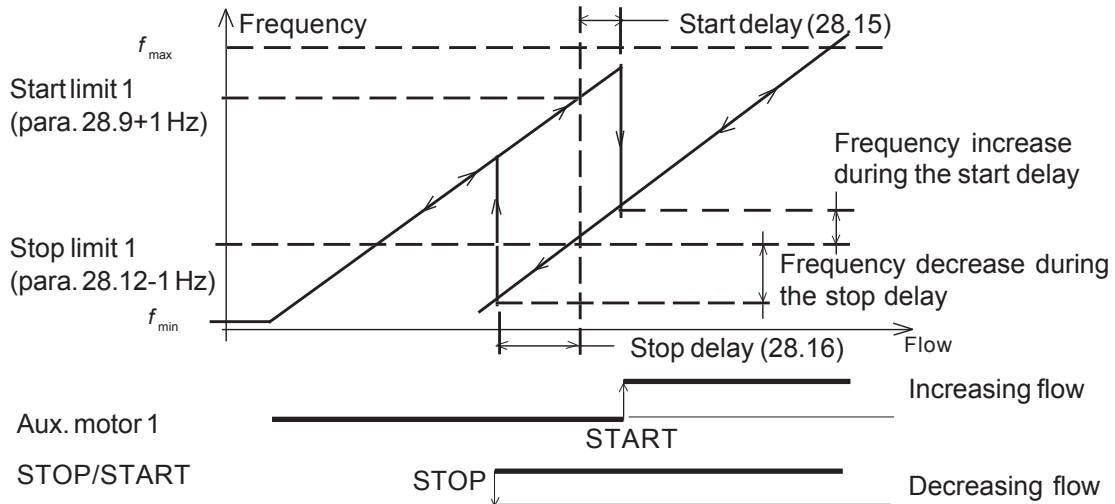

Figure 9-19. Example of pump control.

18 Autochange Interv.

Elapsed time for automatic exchange of the connected motors. The Parameter determines the time after which the starting order of the connected motors will be automatically altered. Alternation is possible only when the actual signal goes below the limit set with parameter 28.19. In basic order, relay output RO1 controls the regulated motor and relays RO2 to RO4 *) control the constant speed motors.

Setting the value 00 h 00 min disables the automatic exchange function and basic order will be used. The interval time counter is only active when the SAMI GS is running.

19 Autochange Level

Actual value below which automatic exchange of the connected auxiliary motors will occur after the time set with parameter 28.18 has elapsed.

Setting the value 0 % ensures automatic exchange takes place when the SAMI GS is stopped (normal or "sleep"). After this, start takes place only when giving a new start command. The autochange level is related to the set max. frequency and to the capacity of the system. If the value of the parameter is set to 45 % and the system has only two

motors, the automatic exchange takes place at the frequency of $(45/50) * f_{max}$. If auxiliary motors are connected, the percentage value corresponding to the set max. frequency is:

1+1	motors	50.0%
1+2	-"	33.3%
1+3	-"	25.0%

The exchange takes place if the following conditions are valid:

- autochange interval time has elapsed
- actual value is below the set autochange level
- minimum one auxiliary motor is not running
- SAMI GS does not run at a constant frequency (see parameter 11.7).

When all the conditions are valid the PFC stops all motors, changes the order of the motors and restarts motors using the new start order. The start order cannot be changed externally.

The start order and the elapsed run time remain in the memory during a mains interruption.

Note! If only the regulated pump is used, cancel the autochange operation, para. 28.18 = 00 h 00 min. This releases relay outputs RO2 to RO4 *) for other use.

*) RO4 only available with I/O Extension card SNAT

7520 IOE

20 Interlocks

If this parameter is set to ON and one of the interlocking signals disappears while in run status, the SAMI GS stops and all output relays (RO1 to RO4*) are released.

If other motors are available, the PFC connects one of those instead and starts the SAMI GS again. If this parameter is set to "OFF", the interlocking function is disabled and DI2, DI3 and DI4 (DI7*) can be programmed for other purposes.

*) available only with I/O Extension card SNAT 7520 IOE

21 Error Value Inv

The parameter determines whether or not the PI-Controller error signal is inverted.

22 Actual 1 Input

The parameter determines which of the analogue inputs is actual value 1 (ACT1). AI3 and AI4 can be set if the I/O extension card is in use. STD COMMU = control via RS 485 serial link. The Parameter value can be changed only in stop status.

23 Actual 2 Input

The parameter determines which of the analogue inputs is actual value 2 (ACT2). AI3 and AI4 can be set if the I/O extension card is in use. The Parameter value can be changed only in the stop status.

24 Actual Value Sel

The following mathematical operations can be performed with the actual signals:

- ACT1 ACT1 without any operations
- ACT1-ACT2 Difference of ACT1 and ACT2
- ACT1+ACT2 Sum of ACT1 and ACT2
- ACT2 * ACT2 Product of ACT1 and ACT2
- MIN(A1,A2) Min. value of ACT 1 and ACT2

- MAX(A1,A2) Max. value of ACT1 and ACT2
- sqrt(ACT1) Square root of ACT1
- sqA1+sqA2 Sum of sq. roots of ACT1 and ACT2

All operations are performed to the scaled values. Square root signals can be used for example for flow control where the measured actual value is pressure.

25 ACT1 Min Scale,

27 ACT2 Min Scale

Scaling factor to match ACT1 (ACT2) to a minimum value of the reference signal.

26 ACT1 Max Scale

28 ACT2 Max Scale

Scaling factor to match ACT1 (ACT2) to a maximum value of the reference signal.

29 Regul Bypass Ctrl

Bypass selection of the PI-Controller. If bypassed, the actual value acts as a direct speed reference for the regulated motor. Automatic start and stop of constant speed motors also refers to the actual value signal instead of the output of the PI-Controller. See

Frequency = $f(\text{ACT } 1)$

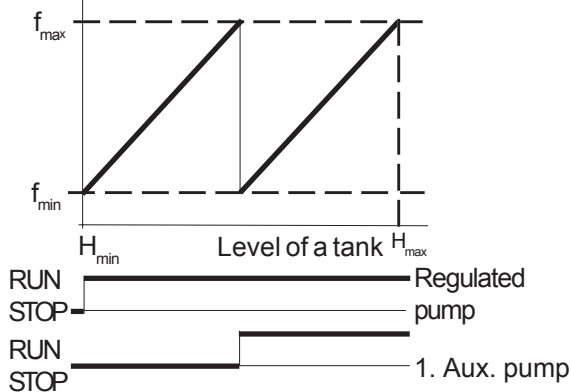

Figure: 9-20. Example of flow control of precipitation tanks using PI-Controller bypass function.

Figure below.

30 Display Unit

Unit of ACT 1 and ACT 2 shown on the display. Units: bar, %, m/s, C (= °C), kPa,

l/min, m³/min.

31 Displ Unit Scale

Scaling factor for display unit.

32 NBR of Decimals

Number of decimal digits of the displayed actual values.

9.3 Main 30 - Protection

9.3.1 Group 31 - Supervision

These values can be altered with the SAMI GS running.

Parameter	Range/Unit	Description
1 Output Freq1 Func	No/Lowlimit/Highlimit	Output Frequency 1 supervision
2 Output Freq1 Lim	0...120/500 Hz*)	Output Frequency 1 supervision limit
3 Output Freq2 Func	No/Lowlimit/Highlimit	Output Frequency 2 supervision
4 Output Freq2 Lim	0...120/500 Hz*)	Output Frequency 2 supervision limit
5 Current Func	No/Lowlimit/Highlimit	Motor Current supervision
6 Current Lim	0...2*I _N [A]	Motor Current supervision limit
7 Ref1 Func	No/Lowlimit/Highlimit	Reference 1 supervision
8 Ref1 Lim	0...120/500 Hz*)	Reference 1 supervision limit
9 Ref2 Func	No/Lowlimit/Highlimit	Reference 2 supervision
10 Ref2 Lim	0...100%	Reference 2 supervision limit
11 Supervis Messages	On/Off	Supervision messages on the display

*) Max. value is set automatically according to the setting of parameter 22.4.

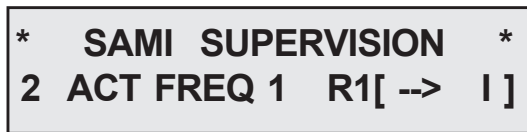

Figure 9-21. Example of supervision display.

1 Output Freq1 Func

3 Output Freq2 Func

These parameters allow you to activate an Output Frequency supervision function. A Relay Output (para. 14.3 - 14.5) and the display are used to indicate that the Output Frequency has dropped below (LOWLIMIT) or exceeded (HIGHLIMIT) the supervision limit.

5 Current Func

Motor Current supervision. Operation as in parameter 1 OUTPUT FREQ1 FUNC.

7 Ref1 Func, 9 Ref2 Func

Reference supervision. Operation as parameter 1 OUTPUT FREQ1 FUNC.

11 Supervis Messages

ON = Supervision messages will be shown on the display.

OFF = Supervision messages will not be shown on the display. Relays operate if programmed for supervision signals.

9.3.2 Group 32 - Fault Function

These values can be altered with the SAMI running.

Parameter	Range/Unit	Description
1 Serial Fault Func	Stop/Const Freq	Operation following Serial Comm. fault
2 AI < 2 V/4 mA Func	No/Warning/Fault/ Const Freq	Operation following AI<2 V/4 mA fault
3 Mot Temp Flt Func	No/Warning/Fault	Operation following motor overtemp.
4 Motor Therm Time	300...10000s	Time for 63 % motor temperature rise
5 Motor Load Curve	50...150 %	Motor current maximum limit
6 External Fan	No/Yes	Motor equipped with external cooling fan
7 Stall Func	No/Warning/Fault	Operation following motor stall
8 Stall Current	0...1.5*I _N [A]	Current limit for Stall Protection logic
9 Stall Time/Freq	10s/15Hz or 20s/25Hz or 30s/35Hz	Time/Freq. limit for Stall Protection logic
10 Underload Func	No/Warning/Fault	Operation following Underload fault
11 Underload Time	0...600s	Time limit for Underload logic
12 Underload Curve	1...5	Torque limit for Underload logic

1 Serial Fault Func

This parameter allows you to select the preferred operation in case of a malfunction in the serial communication between the Control Interface and Motor Control Card.

STOP

The SAMI GS stops according to the setting of parameter 26.3, STOP FUNCTION.

CONST FREQ

The SAMI drives the motor at constant frequency selected with parameter 24.7.

Note! If the selected control place is KEYPAD, the SAMI GS stops in case of a serial communication fault.

2 AI < 2V/4mA Func

This parameter allows you to select the preferred operation when the Analogue Input (1 or 2) signal drops below 2V/4mA and the minimum is set to 2V/4mA ("living zero").

NO

No activity required.

WARNING

Warning indication on display.

FAULT

Fault indication on display and the drive has stopped according to the setting of parameter 26.3 STOP FUNCTION.

CONST FREQ

The SAMI GS drives the motor with the constant frequency selected by parameter 24.7.

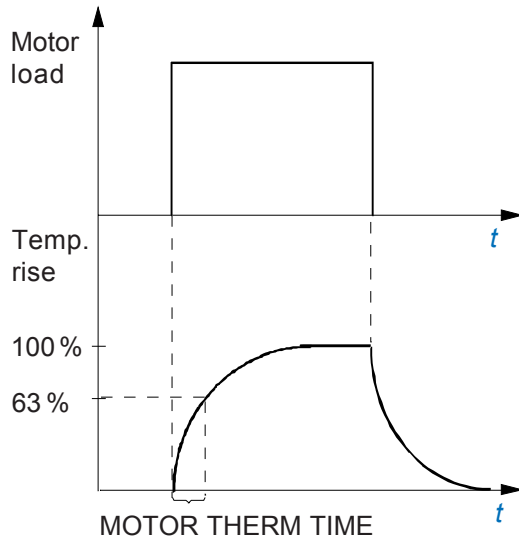

Figure 9-22. Motor thermal time.

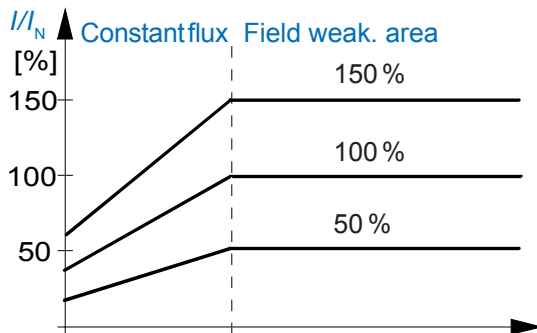

Figure 9-23. Motor load curve (EXTERNAL FAN = NO).

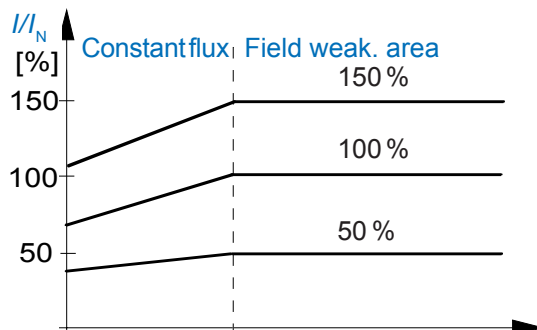

Figure 9-24. Motor load curve (EXTERNAL FAN = YES).

3 Mot Temp Flt Func

This parameter defines the operation of the motor thermal protection function.

No activity required.

Warning indication is displayed when the motor temperature reaches the warning level (95 % of the nominal value).

Warning indication at warning level and fault indication + stop when the motor temperature reaches 100 % level.

4 Motor Therm Time

MOTOR THERM TIME is the time period within which the motor temperature reaches 63 percent of the final temperature rise. As a rule of thumb, MOTOR THERMAL TIME = $120 * t_6$ (t_6 in seconds is given by the motor manufacturer). SAMI GS automatically selects a typical motor thermal time as a default value according to the selected motor power and pole number. Table 9-1, page 68.

5 Motor Load Curve

6 External Fan

The motor connected to the SAMI GS can be protected from overheating by the motor thermal protection. The SAMI GS will calculate the temperature rise of the motor using the following assumptions:

- the ambient temperature is 40 °C
- the motor is at ambient when power is applied to the SAMI GS
- when stopped, the motor cooling time is 4 times the cooling time when running

Motor heating is calculated assuming a load curve. The load curve is defined by the MOTOR LOAD CURVE and EXTERNAL FAN parameters.

Table 9-1. Default values of motor thermal times when motor power and pole number are selected from START-UP Data group. These values are typical for each motor size. Default value of pole number is 4.

P_N [kW]	Number of poles		
	2 t [s]	4 t [s]	6 t [s]
2.2	660	1020	1440
3.0	720	1060	1560
4.0	780	1140	1740
5.5	900	1260	1760
7.5	970	1380	1860
11	1140	1560	2040
15	1200	1740	2340
18.5	1260	1860	2340
22	1380	2040	2760
30	1680	2220	2940
37	1860	2460	3180
45	2040	2640	3420
55	2220	2820	3660
75	2400	3120	3960

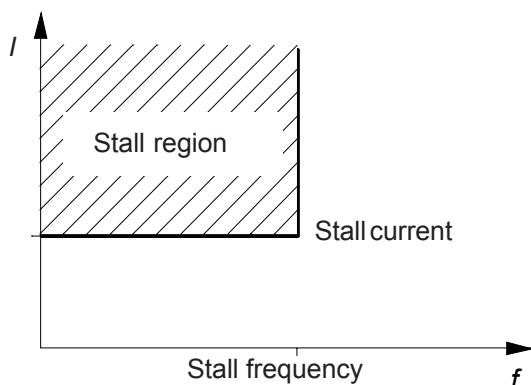

Figure 9-25. Stall Protection.

If MOTOR LOAD CURVE is set to 100 %, the Motor Thermal Protection allows the motor to be loaded with nominal current. The load curve level should be adjusted if, for example, the ambient temperature differs from the nominal value.

The motor temperature will rise above nominal when the motor operates in the region above the curve, and will fall when operated below the curve. The rate of heating and cooling is set by MOTOR THERM TIME.

Because of the simple thermal model used for calculating temperature rise, this technique of thermal protection may cause undesirable trips when the motor is run continuously at low frequencies. If your application requires continuous running at frequencies lower than 25 Hz, you may need to provide external cooling.

When using external cooling, set EXTERNAL FAN to YES. The load curve will be fixed to 70 % current at 0 Hz.



Note! Motor thermal protection will not protect the motor if the cooling efficiency of the motor is reduced due to dust and dirt.

7 Stall Func

This parameter defines the operation (NO/WARNING/FAULT) of the Stall Protection.

The protection is activated if

- 1) the motor current exceeds the limit set in parameter 32.8, STALL CURRENT,
- 2) the output frequency is below the level set in parameter 32.9, STALL TIME/FREQ and
- 3) The motor current remains above and the output frequency below the set level longer than the period set in parameter 32.9.

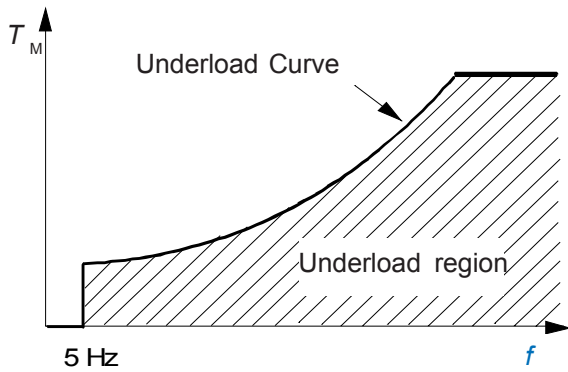

Figure 9-26. Underload Protection.

10 Underload Func

A process malfunction can sometimes appear as a removal of motor load, which is detected by underload protection. The protection is activated if

- 1) the motor torque drops below the load curve selected in parameter 32.12, UNDERLOAD CURVE
- 2) the motor torque remains below the load curve longer than the period set in parameter 32.11, UNDERLOAD TIME and
- 3) the output frequency is more than 5 Hz.

The protection function assumes that the drive is equipped with a nominal size motor.

Select NO/WARNING/FAULT as desired.

Refer to Figure 9-27, for UNDERLOAD CURVE selection.

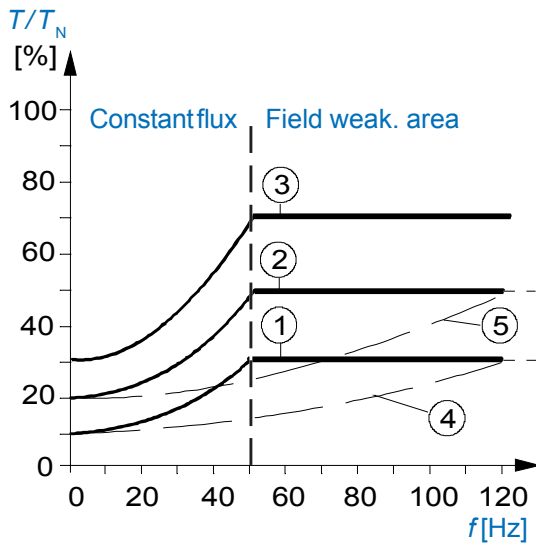

Figure 9-27. The five available curve types in parameter 32.12 UNDERLOAD CURVE.

9.3.3 Group 33 - Automatic Reset

These values can be altered with the SAMI GS running.

Parameter	Range/Unit	Description
1 Number of Trials	0...5	Max. number of trials for Autoreset logic
2 Trial Time	1...180s	Time limit for Autoreset logic
3 Overvoltage	No/Yes	Enable automatic fault reset
4 Undervoltage 1	No/Yes	Enable automatic fault reset
5 Overcurrent	No/Yes	Enable automatic fault reset
6 AI signal <2 V/4 mA	No/Yes	Enable automatic fault reset

1 Number of Trials

2 Trial Time

The maximum number of faults per time period to keep the Automatic Fault Reset System active is given by parameters 33.1 and 33.2.

If more faults occur within TRIAL TIME, the drive stops.

The automatic fault reset system will reset the faults selected with parameters 33.3 - 33.6.

3 Overvoltage

4 Undervoltage

If you select YES, the SAMI GS will resume

operation when the DC bus voltage returns to normal level. If para. 33.1, NUMBER OF TRIALS is set to 0 (and this parameter is set to YES) the undervoltage fault will be continuously reset, and the fault will not be updated in the Fault History. In this case, the fault is virtually undetectable.

5 Overcurrent

If you select YES, the fault is reset and the SAMI GS resumes normal operation.

6 AI Signal < 2V/4mA

If you select YES, the SAMI GS resumes normal operation when the Analogue Input signal recovers the normal level ($\geq 2V/4mA$).

9.3.4 Group 34 - Information

The parameter values can not be altered by the user.

Parameter	Range/Unit	Description
1 Cri Prog Version	CRlxy	Control Interface Card program version
2 MC Prog Version	CNTxy	Motor Control Card program version
3 Test Date	DD.MM.YY	Test date (day.month.year)

1 Cri Prog Version, 2 MC Prog Version

xx are running integers, which correspond to the version. y is a letter corresponding to the revision.

3 Test Date

Replacing the Control Interface Card will result in a new date. To be sure of the date of manufacture, check the name plates on the units or cards.

10 Fault Tracing & Service

10.1 Fault Indications

The SAMI GS continuously monitors itself during operation. If a fault condition should arise, the SAMI GS will display a description of the fault trip and wait for the operator to acknowledge the fault before resuming operation.

The SAMI GS will also display warnings, which indicate abnormal operation, but do not cause the drive to stop. If a fault occurs when a warning display is on, the warning will be erased and the fault indication displayed. Refer to the table on page 73 for warning and fault indications.

10.2 Fault Resetting

A fault can be reset either by pressing the Keypad Start/Stop button, activating the selected Digital Input (parameter 11.9), via serial communication (RS 485) or if necessary, switching the mains voltage off for a while. If the fault has been removed, the SAMI GS will resume normal operation. If the fault has not been removed, the SAMI GS will trip again. For automatic fault reset, refer to Group 33 on page 70.

Note! Fault resetting starts the drive, if Start command is active.

If the fault persists, it will trip the drive again, resulting in a new fault indication. However, to allow parameters to be checked or altered after resetting a fault, there is a 1 minute delay, during which no new faults are displayed, unless Start command becomes active. During this delay, the state of the fault relay output will follow the actual fault situation, as will the fault registering into the Fault History. If the autoreset function is selected, these faults will also be reset.



Some faults require the user to cycle the power off then on before the fault can be cleared. Proper fault reset action is given in the fault message Table on pages 73 - 77.

10.3 Fault History

When a fault is detected, it is stored so that it can be reviewed at a later date. The last three faults and warnings are stored in Operating Data parameters 20 LAST-RECD FAULT, 21 SECOND-RECD FAULT, 22 FIRST-RECD FAULT).

The faults can be checked for trends that may be useful in preventing future faults. For example, if the last 2 out of 3 faults were overvoltage trips, the deceleration time should be increased.

Scrolling through the Fault History parameters does not erase the Fault History. The oldest reset fault indication/warning is automatically erased when a new fault/warning occurs.

To erase the Fault History, each Fault History parameter must be set to zero. Select parameter 20, LAST RECD FAULT and change to Setting mode. Press  or  and the parameter value changes to zero. Return to Display mode by pressing . Repeat the same steps with parameters 21 and 22.

Note! Erasure of the Fault History is prevented, if the fault persists after it has been reset (during the one minute delay discussed in Section 10.2).

Note! Whenever an Application Macro is selected (Start-up Data para. B APPLICATION), the Fault History will also be reset.

```
* * SAMI WARNING * *  
7 A I < 2V/4mA R1[ --> I ]
```

```
* * * SAMI FAULT * *  
*  
8 OVER CURR1 R1[ --> I ]
```

Figure 10-1. Examples of warning and fault displays.

Note! Undervoltage faults are stored in the Fault History only when Automatic Reset is off. Supervision limit indications are not stored in the Fault History but remain on display until reset by pressing I/O or by external fault reset. The source of external fault reset can be selected by parameter 11.9.

Note! Factory testing of the SAMI GS includes tripping function. However, the Fault History is always erased before shipment, which means that any faults within the history have occurred after shipment.

10.4 Fault Tracing with a Fault Display

The Table below shows the displayed fault text, the probable reason for the fault and advice on correcting the fault. The proper fault reset action is indicated below the fault message:







 = Reset with one signal,   = Switch off input power.





If after following the advice given the fault persists, contact the nearest SAMI service representative.





In most cases disturbances are not related to a hardware failure in the SAMI GS, but are caused by unexpected environmental or load conditions.









The principle of all fault tracing is to identify and isolate the cause and then remove it.



If the fault is caused by hardware failure within the SAMI GS, the fault tracing procedure should allow quick on site repair.

Warning message	Possible reason	Remedy
1 SAMI temp 	SAMI GS heatsink temperature > 65 (70)°C. Restricted air flow caused by dust or improper installation.	- Refer to flowchart on page 78.
2 Mot stall 	Parameter 32.7, STALL FUNC is set to WARNING.	- Refer to fault 3, Mot stall.
3 Mot temp 	Parameter 32.3, MOT TEMP FLT FUNC is set to WARNING.	- Refer to fault 4, Mot temp.
6 Under Id 	Parameter 32.10, UNDERLOAD FUNC is set to WARNING.	- Refer to fault 7, Under Id.
7 AI <2V/4mA 	Parameter 32.2, AI <2V/4mA FUNC is set to WARNING.	- Refer to fault 11, AI <2V/4mA.
8 EEPROM wr 	Parameter storage to EEPROM has failed.	<ul style="list-style-type: none"> - Check DC-link voltage. - If voltage is OK, try to store again. - If warning occurs again, try to restore factory settings. - If the warning persists, contact the nearest SAMI service representative.
10 Op card 1 	Speed Control Macro selected but no Pulse Tachometer Card connected.	<ul style="list-style-type: none"> - Check the connections. - Check that the card is present.

Fault message	Possible reason	Remedy
1 Start/Stop 	The start/stop reference from the Control Interface Card is different from the start/stop state of the Motor Control Card.	<ul style="list-style-type: none"> - Check the connection between Control Interface and Motor Control Cards. - If the fault persists, contact the nearest SAMI service representative.
2 SAMI temp 	Heatsink temperature >70°C (>75 °C for ACS 501-050-3, 060-3, 060-5, 070-5) or less than -5 °C. Restricted air flow caused by dust or improper installation; overloading or component failure (fan, fuse, power semiconductors). If the display shows -10 °C temperature, when the ambient (heatsink) obviously is warmer, R10 circuit has opened. If +100 °C is shown R10 is in a short circuit.	<ul style="list-style-type: none"> - Refer to flow chart page 78. - Check R10 circuit (see fig. 10-4 page 81).
3 Mot stall 	The SAMI GS has determined that the motor is operating in the stall region. Refer to STALL TIME/FREQ parameter. The motor is not turning because of increased load torque. Motor may be too small for the application.	<ul style="list-style-type: none"> - Remove mechanical problem causing increased load torque. - If the motor shaft is rotating and the motor is not overheating, increase stall limit parameters. - Check dimensioning, use larger SAMI GS and motor if necessary.
4 Mot temp 	The SAMI GS has determined that there is a high probability that the motor is overheated. Because the temperature rise is calculated from the motor current and not measured directly, the motor may be within temperature specification.	<ul style="list-style-type: none"> - Check the motor temperature. If it is within temperature specification, increase MOTOR LOAD CURVE and/or MOTOR THERM TIME and restart. - If the motor temperature is above rated temperature, improve motor cooling or resize the motor.
7 Under Id 	The motor load has dropped below the supervision limit set by parameters 32.11 and 32.12.	<ul style="list-style-type: none"> - Remove mechanical problem causing underload. - Check motor load cycle and increase UNDERLOAD TIME or change UNDERLOAD CURVE.

Fault message	Possible reason	Remedy
8 Overcurr1(...4) 	The output current has exceeded 265% I_N . This can be caused by a short circuit or earth fault in the motor, motor cable or in the SAMI GS. Too short an acceleration time may also cause an overcurrent trip.	<ul style="list-style-type: none"> - Overcurr1: 265%*I_N exceeded - Overcurr2, 3: Gate drive fault - Overcurr4: Interference fault - Refer to flowchart on page 79.
9 Overvolt 	DC-bus voltage has exceeded 135 % nominal voltage (nom. Volt. = $1.35 * U_{1_{max}}$; $U_{1_{max}} = 415/500$ V). Most common cause is overvoltage (static or transient) in the mains supply. Overvoltage can result also, when the motor runs as a generator in drives where the load inertia is extremely high and the deceleration time is set low.	<ul style="list-style-type: none"> - Check the mains supply for static or transient overvoltages (e.g. are there generating loads or large power factor correction capacitors upstream?) - Use longer deceleration time or - Use coasting stop function if it is compatible with the application. - If short decel. time is needed use Dynamic Braking Device.
10 Underv1 	DC-bus voltage has gone below 65 % of U_N (Start-Up Data para. D). Most common reason for low voltage trip is failure in the mains supply, loss of phase or "brown out" condition.	<ul style="list-style-type: none"> - Check mains fuses and supply. - If mains supply is adequate, an internal failure has occurred. Contact the nearest SAMI GS service representative.
11 AI <2V/4mA 	Analogue input less than 2V/4mA and minimum has been set to 2V/4mA.	<ul style="list-style-type: none"> - Input reference has failed or control wire is broken. Check the reference circuit.
14 Op Card 1 	The frequency converter software does not receive the optional board SNAT 7610 BAC identification code (card not connected or failed). The drive stops according to the setting of parameter 26.3 STOP FUNCTION.	<ul style="list-style-type: none"> - SPEED CONTROL application macro can not be used without optional board SNAT 7610 BAC. Select any other macro. If SNAT 7610 BAC is used see its Operation Guide.

Fault message	Possible reason	Remedy
16 Pow Rang  	Power range programming does not match after replacing the Control Interface or Motor Control Card.	<ul style="list-style-type: none"> - Check the power range programming on Motor Control Card. - Check that the Start-up Data is given accordingly for the new Control Interface Card. - Remove power, wait one minute, then restore power. If the fault persists, contact the nearest SAMI service representative.
17 RS 485 	No serial communication on RS 485 at connector X51. EMC disturbances on serial link.	<ul style="list-style-type: none"> - If no ser. communication ought to be present set para. 17.4 to "NO" - Check connectors, bit rate. - Check parameter 17.3. - Remove reasons for disturbances.
19 In comms 	Failure in serial communication within the Control Interface and/or Motor Control Cards.	<ul style="list-style-type: none"> - Check the cabling between Control Interface and Motor Control Card. - If the fault persists, contact the nearest SAMI service representative.
20 Con intX  	This fault is related to components on the Control Interface Card.	<ul style="list-style-type: none"> - Remove power, wait one minute, then restore power. If the problem persists, call the nearest SAMI GS service representative. Record the specific fault code, you may be asked for it.
21 Mot contX  	This fault is related to components on the Motor Control Card.	<ul style="list-style-type: none"> - Remove power, wait one minute, then restore power. If the problem persists, call the nearest SAMI GS service representative. Record the specific fault code, you may be asked for it.
22 Par rest 	Parameter restoring error. Parameter checksum does not match.	<ul style="list-style-type: none"> - Reset fault display (the display is reset allowing parameters to be scrolled, but the fault is not reset). - Check all parameter settings or reset the factory settings. - Remove power, wait 1 minute, then restore power to check that the fault has disappeared.

Fault message	Possible reason	Remedy
<p>23 Underv2</p> 	<p>DC voltage does not rise over 85% of its nominal value ($1.35 \cdot U_N$) within 5 sec. of connecting the mains. In RUN status DC voltage remains below 65% and Fault 10 Undervoltage 1 occurs. If automatic reset is enabled with para. 33.4, Fault 23 Undervoltage 2 is indicated if recharging to 85 % of DC voltage is not possible in 3 min.</p>	<ul style="list-style-type: none"> - Check mains supply. - If mains supply is adequate, an internal failure has occurred. Contact nearest SAMI service representative.
<p>24 Earth fl</p> 	<p>Earth fault in the motor, motor cable or motor output terminal of the SAMI GS. Due to capacitive leakage current, the fault might also appear in multimotor applications where several motor cables are connected in parallel.</p>	<ul style="list-style-type: none"> - Check the insulation of the motor and motor cables. If no earth fault or short-circuit between phases exists, contact the nearest SAMI service representative.

Flowchart 10-1. SAMI temperature warning/fault

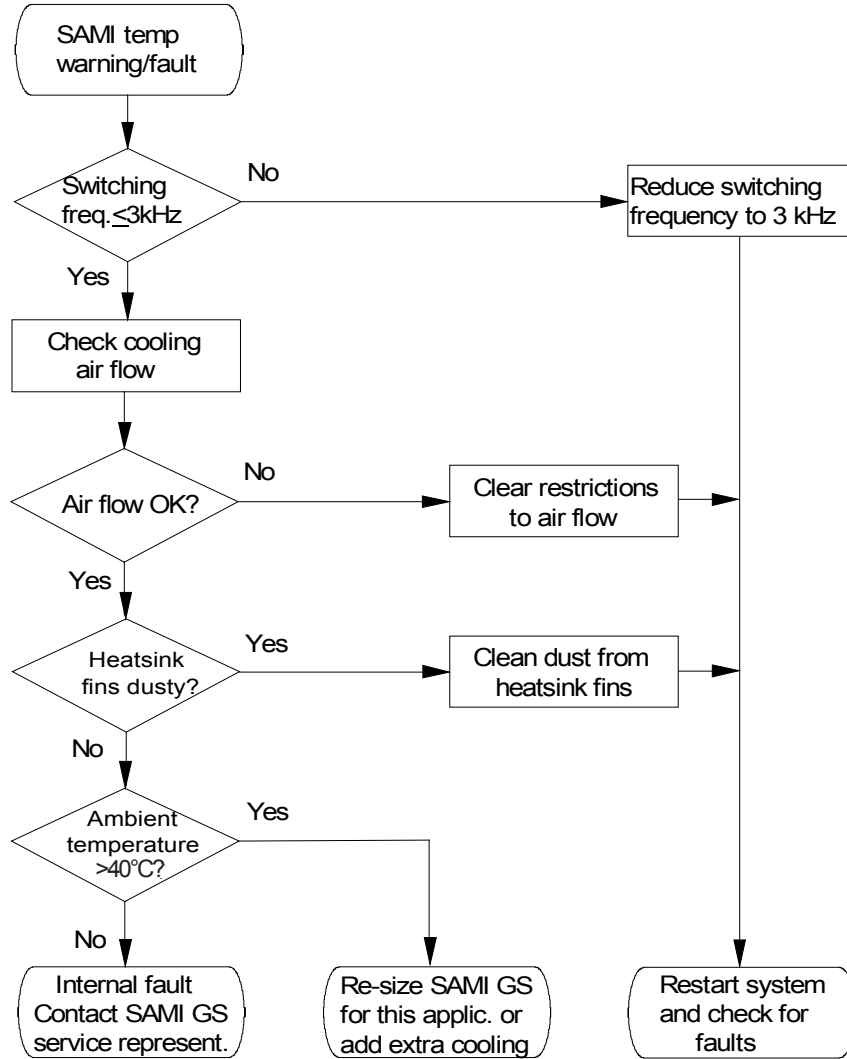

Flowchart 10-2. Overcurrent fault

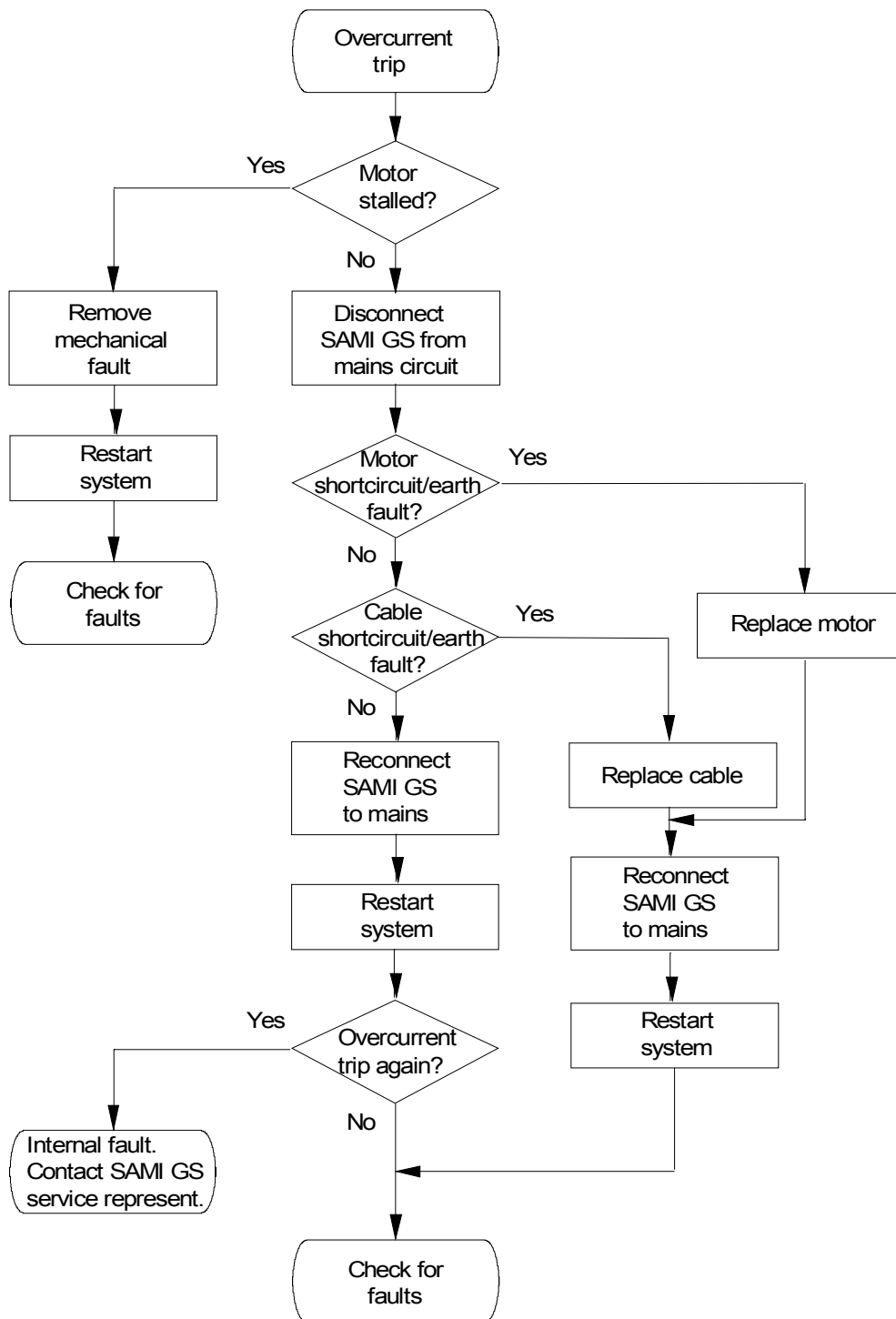

10.5 Service

Note! Pay attention to the Safety Instructions on page 2 before proceeding with any measurements!

Checking DC-link capacitors

ACS 501-004-3, 005-3 and 006-3
ACS 501-005-5, 006-5 and 009-5
 (refer to page 81 for other units).

1. Disconnect SAMI from the mains.
2. Ensure (see page 29) that the SAMI is safe before proceeding with these measurements.
3. Disconnect all the control wiring (X50 can be disconnected in one piece) from the Control Interface Card and remove the Card to allow access to the Motor Control Card.

A) With a multimeter

Switch the multimeter to 1 kΩ scale. Measure the resistors R3,R6,R11*. The multimeter should indicate a value which rises constantly, stabilising after a while (see Table 10-1).

Table 10-1. Values for discharging resistors and DC capacitors.

ACS 501	R3,R6*,R11	C6,C8,C7*	C6,C8,C7*
		Factory	Spares
004-3	100 kΩ	330 μF	680 μF
005-3	100 kΩ	680 μF	680 μF
006-3	100 kΩ	680 μF	680 μF
005-5	100 kΩ	510 μF	1050 μF
006-5	100 kΩ	1050 μF	1050 μF
009-5	100 kΩ	1050 μF	1050 μF

Components marked with * are only available in 500 V units. If the reading is different from the values given, the resistors or the capacitors (on the other side of the card) are faulty. Contact the nearest SAMI service representative.

Alternatively, capacitor values may be measured directly with the multimeter (e.g. FLUKE 79).

B) With an insulation tester

A multimeter may not indicate faulty capacitors which can withstand voltages up to 300 V, but not normal mains voltage levels. Therefore, it is recommended that capacitors be also tested with a DC insulation tester (Megger) or suitable DC-voltage source (300V DC range).

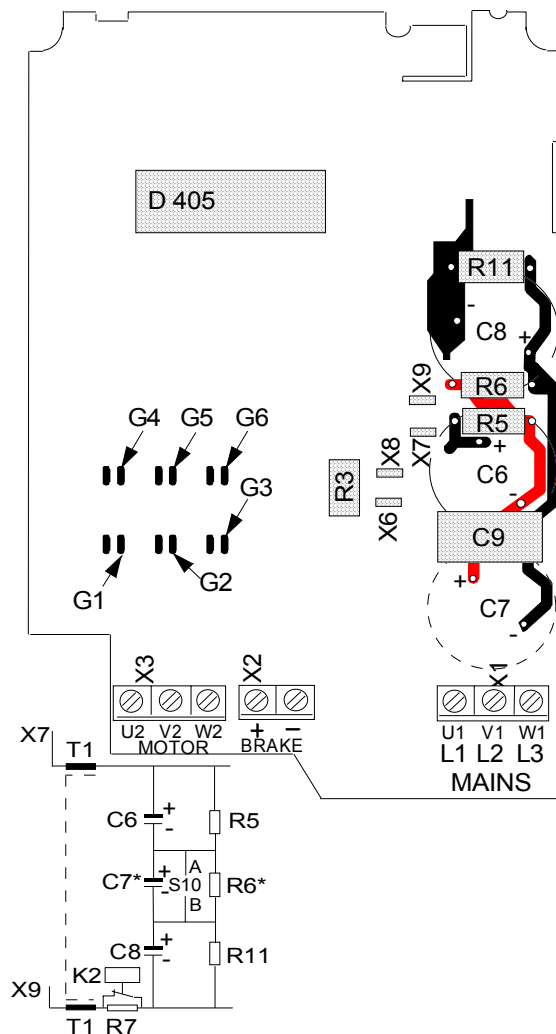

Figure 10-2. Motor Control Card
 ACS 501-004-3, 005-3 and 006-3
 ACS 501-005-5, 006-5 and 009-5.

Checking DC-link capacitors

ACS 501-009-3 ... 060-3
ACS 501-011-5 ... 070-5

1. Disconnect SAMI from the mains.
2. Ensure (see page 29) that the SAMI is safe before proceeding with these measurements.
3. Disconnect all wiring from the DC-link capacitors to allow them to be measured separately.

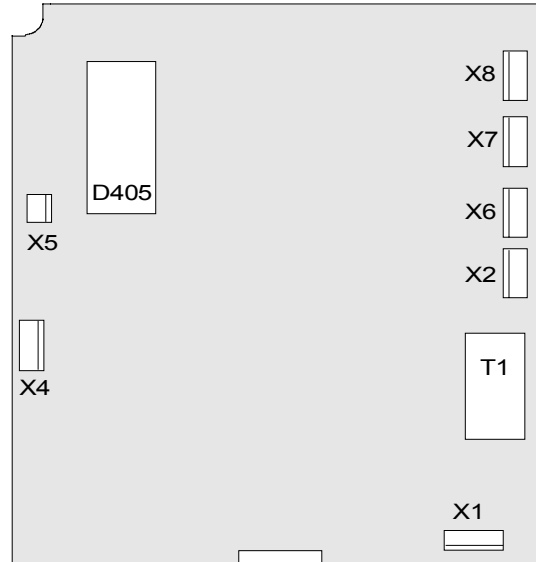
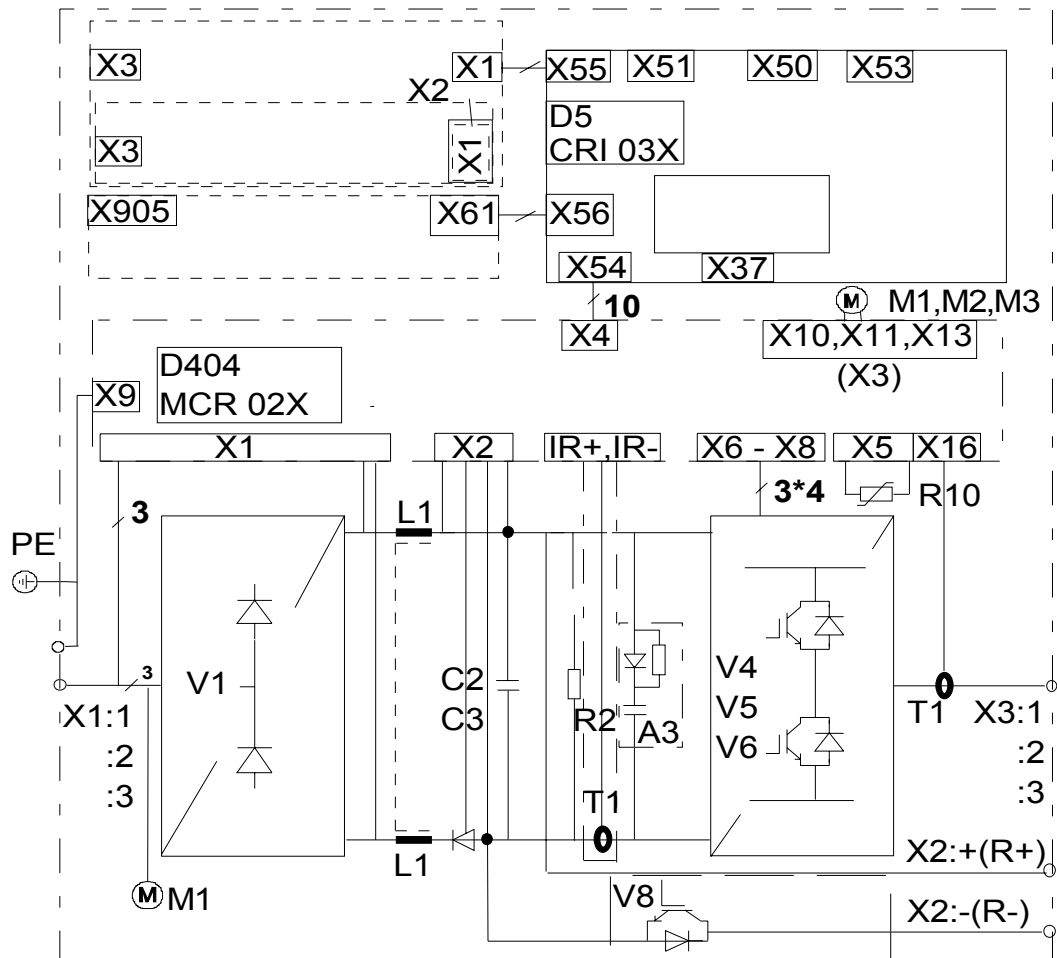

Figure 10-3. Motor Control Card
 ACS501-009-3 ... 070-5.

Figure 10-4. Main circuit diagram
 ACS501-009-3 ... 070-5.



Measurements

A) With multimeter

1. Switch the multimeter to 1 k Ω scale.
2. Connect the positive measuring wire to the + pole of the capacitor and negative wire to the - pole. **Note!** In digital instruments the + pole of the instrument is positive when measuring resistance. In analog instruments the + pole is usually negative.
3. The multimeter should now read a small resistance which then rises towards infinity. If the reading remains below 100 k Ω , the capacitor must be replaced. Contact the nearest SAMI service representative.

Alternatively, capacitor values may be measured directly with the multimeter (e.g. FLUKE 79).

B) With an insulation tester

A multimeter may not indicate faulty capacitors which can withstand voltages up to 300 V, but not normal mains voltage levels. Therefore, it is recommended that capacitors be also tested with a DC insulation tester (Megger) or suitable DC-voltage source.

1. Connect the + wire to the + pole of the capacitor and the - wire to the - pole.
2. Select 300 V DC range.
3. Switch on the tester.
4. The tester should now read a small resistance, which then rises towards infinity.
5. Continue the measurement until the tester reading has stabilised or the voltage falls suddenly.
6. If the reading suddenly falls, the capacitor must be replaced. Contact the nearest SAMI service representative.

IGBT module measurements**ACS 501-004-3 ... 060-3****ACS 501-005-5 ... 070-5**

Note! The IGBT transistor is sensitive to static discharges. Ensure that the meter and its operator are properly grounded during measurement.

1. Disconnect the SAMI from the mains.
2. Ensure (see page 29) that the SAMI is safe before proceeding with these measurements.
3. Disconnect motor cable.
4. Disconnect all the control wiring (X50 can be disconnected in one piece) from the Control Interface Card and remove the Card to allow access to the Motor Control Card.
5. (Only in 009-3...060-3, 011-5...070-5)
Disconnect terminals X6, X7 and X8 on the Motor Control Card.
6. (Only for 009-3...060-3, 011-5...070-5)
Disconnect all the control wiring from the Motor Control Card and remove the Card to allow access to the IGBTs.
7. Use the multimeter and select the Diode Test function.
8. Make measurements according to the following tables.
9. If the readings are different from the Table values, contact the nearest SAMI service representative.

Table 10-1. IGBT module measurements (Collector-Emmitter) ACS 501-004-3... 006-3, 005-5... 009-5.

Multi-meter	X3	Multi-meter	X2	Reading
+	U2	-	+	≅ 0.4 V
+	U2	-	-	∞
+	V2	-	+	≅ 0.4 V
+	V2	-	-	∞
+	W2	-	+	≅ 0.4 V
+	W2	-	-	∞
-	U2	+	+	∞
-	U2	+	-	≅ 0.4 V
-	V2	+	+	∞
-	V2	+	-	≅ 0.4 V
-	W2	+	+	∞
-	W2	+	-	≅ 0.4 V

Example: Connect the + wire to the U2 pole of terminal X3 and the - wire to the + pole of terminal X2. The reading should be approx. 0.4 V. Refer to Figure 10-2 for measuring points.

Note! If terminal X2 is marked R+ and R-, measure + and - from the DC link capacitors (see Figure 10-2).

Table 10-2. IGBT module measurements (Gate (Base)- Emmitter and Gate (Base)- Collector).

ACS 501-004-3... 006-3, 005-5... 009-5.

Multi-meter	MC Card	Multi-meter	X2	X3	Read. [V]
+	G1	-		U2	≅ 1.5
+	G1	-	+		≅ 1.5
+	G2	-		V2	≅ 1.5
+	G2	-	+		≅ 1.5
+	G3	-		W2	≅ 1.5
+	G3	-	+		≅ 1.5
+	G4	-		U2	≅ 1.2
+	G4	-	-		≅ 1.2
+	G5	-		V2	≅ 1.2
+	G5	-	-		≅ 1.2
+	G6	-		W2	≅ 1.2
+	G6	-	-		≅ 1.2

Table 10-3. IGBT module measurements (ACS 501-009-3...060-3, 011-5... 070-5).

Example: Connect + wire to C1 and - wire to E1. The reading should be ∞.

Multi-meter	Tran-sistor	Multi-meter	Tran-sistor	Reading
+	C ₋	-	E ₋	∞
-	C ₋	+	E ₋	≅ 0.35 V
+	B ₋	-	C ₋	∞
+	B ₋	-	E ₋	∞

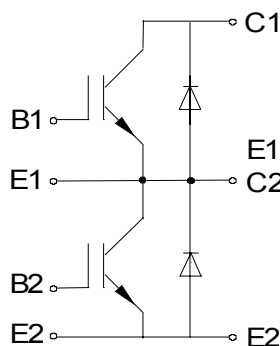

Checking rectifier

ACS 501-004-3 ... 006-3

ACS 501-005-5 ... 009-5

1. Disconnect SAMI from the mains.
2. Ensure (see page 29) that the SAMI is safe before proceeding with these measurements.
3. Disconnect all the control wiring (X50 can be disconnected in one piece) from the Control Interface Card and remove the Card to allow access to the Motor Control Card.
4. Disconnect the choke wires from terminals X6, X7, X8 and X9.
5. Select Diode Test function from the multimeter. If your multimeter does not have a Diode Test function, proceed to "Alternative measurement" on page 84.

6. Connect the negative measuring wire to X6.
7. Measure all the phase poles of terminal X1. The reading should be about 0.5 V.
8. Change polarity of the multimeter wires and repeat the measurement. The reading should be infinity.
9. Make a measurement between X6 and X8. The reading should be about 0.8 V and infinity. If the readings are different from the values given, the rectifier module must be changed.

Alternative measurement

10. Select 1k Ω range on the multimeter (not Diode Test function).
11. Carry out the measurements (6 - 9) as above. The reading should be 100 Ω ... 10 k Ω and infinity accordingly. **Note!** In digital instruments, the + pole of the instrument is positive when measuring resistance. In analogue instruments, the + pole is usually negative.
12. Connect the positive measuring wire to X8. Repeat all the measurements against the negative pole.
13. If the readings are different from the values given, the rectifier module must be changed.

Checking rectifier

ACS 501-009 -3 ... 060-3
ACS 501-011-5 ... 070-5

1. Disconnect SAMI from the mains.
2. Ensure (see page 29) that the SAMI is safe before proceeding with these measurements.
3. Disconnect all the control wiring (X50 can be disconnected in one piece) from the Control Interface Card and remove the Card. Disconnect all the control wiring from the Motor Control Card and remove the Card to allow access to the rectifier.
4. Disconnect all wires from the rectifier terminals.
5. Select Diode Test function on the multimeter. If your multimeter does not have a Diode Test function, proceed to alternative measurement on page 85.
6. Connect the negative measuring wire to the positive rectifier terminal.

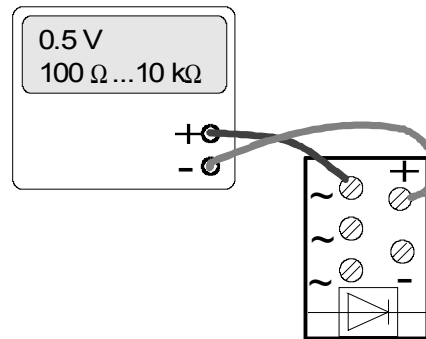

7. Measure all the rectifier phase poles. The reading should be about 0.5 V.

8. Change polarity of the multimeter wires and repeat the measurement. The reading should be infinity.

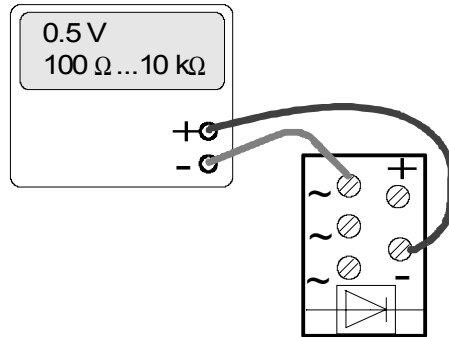
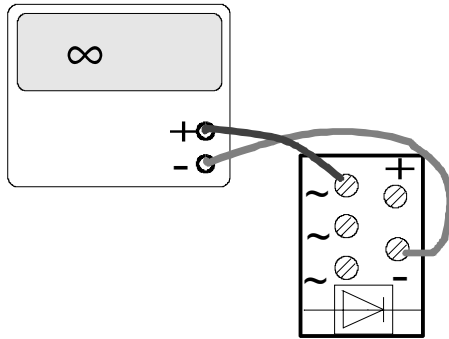

9. Measure between + and - of the rectifier. The reading should be about 0.8 V and infinity. If the readings are different from the values given, the rectifier module must be changed.

Alternative measurement

10. Select 1kΩ range on the multimeter (not Diode Test function).
11. Carry out the measurements (6.-9.) as above. The reading should be 100 Ω ... 10 kΩ and infinity accordingly. **Note!** In digital instruments, the + pole of the instrument is positive when measuring resistance. In analogue instruments, the + pole is usually negative.
12. Connect the positive measuring wire to the negative pole of the rectifier. Repeat all the measurements against the negative pole.

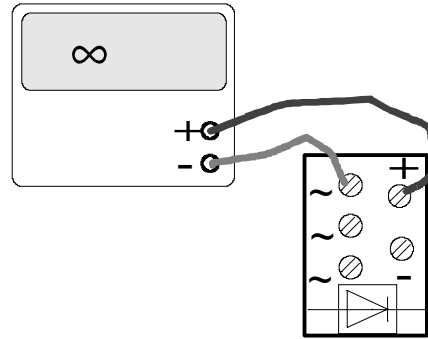

13. If the readings are different from the values given, the rectifier module must be changed.

10.6 Spare parts

Code	Name	ACS501-004-3	ACS501-005-3	ACS501-006-3	ACS501-009-3	ACS501-011-3	ACS501-016-3	ACS501-020-3	ACS501-025-3	ACS501-030-3	ACS501-041-3	ACS501-050-3	ACS501-060-3	ACS501-005-5	ACS501-006-5	ACS501-009-5	ACS501-011-5	ACS501-016-5	ACS501-020-5	ACS501-025-5	ACS501-030-5	ACS501-041-5	ACS501-050-5	ACS501-060-5	ACS501-070-5
Component boards																									
60038554	Motor control SNAT 7030-SP2 compl.	1	1	1										1	1	1									
60038511	Motor control SNAT 7050-SP2 compl.				1	1											1	1							
60038546	Motor control SNAT 7070-SP2 compl.						1	1											1	1					
60036381	Motor control SNAT 7120-SP2 compl.								1	1	1	1	1								1	1	1	1	1
61027319	Ctrl interface +Display cards 2Mb SNAT 7600/7640+SNAT 7680 cards	1	1	1	1	1	1	1	1	1	1	1	1	1	1	1	1	1	1	1	1	1	1	1	1
61052674	I/O Extension Card SNAT 7520	1	1	1	1	1	1	1	1	1	1	1	1	1	1	1	1	1	1	1	1	1	1	1	1
61049614	Bus Adapt. & Pulse Tacho. SNAT 7610	1	1	1	1	1	1	1	1	1	1	1	1	1	1	1	1	1	1	1	1	1	1	1	1
61042105	RS 232/20mA Comboard SNAT 7690	1	1	1	1	1	1	1	1	1	1	1	1	1	1	1	1	1	1	1	1	1	1	1	1
61096787	Profibus interface card SNAT 7700	1	1	1	1	1	1	1	1	1	1	1	1	1	1	1	1	1	1	1	1	1	1	1	1
Rectifiers																									
31128811	3~ -module/6 diodes (V1)				1	1											1	1							
60008281	3~ -module/6 diodes (V1)						1	1											1	1					
60008400	3~ -module/6 diodes (V1)								1	1											1	1			
60008515	3~ -module/6 diodes (V1)										1												1		
60024146	3~ -module/6 diodes (V1)											1	1											1	1
Transistor modules																									
60007357	IGBT -mod. 2 • 50 A/1200 V (V4..V6)				3	3											3	3							
60021007	IGBT -mod. 2 • 75 A/1200 V (V4..V6)						3											3							
60021015	IGBT -mod. 2•100 A/1200 V (V4..V6)							3	3											3	3				
60021023	IGBT -mod. 2•150 A/1200 V (V4..V6)									3	3											3	3		
60021031	IGBT -mod. 2•200 A/1200 V (V4..V6)											3	3											3	3
Charging switches																									
31163528	Thyristor (V2)				1	1											1	1							
31163536	Thyristor (V2)						1	1	1	1	2	2	2						1	1	1	1	2	2	2
DC-capacitors pcs/set																									
60018782	1500 µF/350 V complete 2 (C2-C3)				1	1																			
60031363	2200 µF/350 V complete 2 (C2-C3)						1	1																	
60031371	3300 µF/350 V complete 2 (C2-C3)								1	1															
60031380	4700 µF/350 V complete 2 (C2-C3)										1	1	1												
60031398	2330 µF/280 V complete 3 (C1-C3)																1	1							
60031401	3410 µF/280 V complete 3 (C1-C3)																	1	1						
60031410	5120 µF/280 V complete 3 (C1-C3)																			1	1				
60031428	7290 µF/280 V complete 3 (C1-C3)																					1	1	1	
Other electrical parts																									
60015074	Recovery module (A3)				2	2											2	2							
60024031	Recovery module (A3)											2	2						2	2	2	2	2	2	2
60024065	Clamping capacitor (A3C.)						2	2	2	2	2	2	2						2	2	2	2	2	2	2
60024057	Clamping diode (A3V.)						1	1	1	1	1	1	1						1	1	1	1	1	1	1
60012415	Cable: Ctrl Interface - Motor Control	1	1	1	1	1	1	1	1	1	1	1	1	1	1	1	1	1	1	1	1	1	1	1	1

Code	Name	ACS501-004-3	ACS501-005-3	ACS501-006-3	ACS501-009-3	ACS501-011-3	ACS501-016-3	ACS501-020-3	ACS501-025-3	ACS501-030-3	ACS501-041-3	ACS501-050-3	ACS501-060-3	ACS501-005-5	ACS501-006-5	ACS501-009-5	ACS501-011-5	ACS501-016-5	ACS501-020-5	ACS501-025-5	ACS501-030-5	ACS501-041-5	ACS501-050-5	ACS501-060-5	ACS501-070-5
Fans																									
60012377	Heat sink fan IP21 (M1,M2)	1	1	1	2	2								1	1	1	2	2							
60012849	Heat sink fan IP54 (M1,M2)	1	1	1	2	2								1	1	1	2	2							
60013365	Heat sink fan (M1)						1	1											1	1					
60013977	Heat sink fan (M1)							1	1		1	1	1								1	1		1	1
60022721	Internal fan IP21 (M3)			1	1	1	1	1	1	1	1	1	1			1	1	1	1	1	1	1	1	1	1
60022721	Internal fan IP54 (M3)	1	1	1	1	1	1	1	1	1	1	1	1	1	1	1	1	1	1	1	1	1	1	1	1
Connectors																									
61117580	Ctrl interf. card X50,X51 (loose part)	1	1	1	1	1	1	1	1	1	1	1	1	1	1	1	1	1	1	1	1	1	1	1	1
Mechanical parts																									
60018847	Cable entry (IP21)	1	1	1	1	1								1	1	1	1	1							
60031461	Cable entry (IP21)						1	1											1	1					
60031479	Cable entry (IP21)								1	1	1	1	1								1	1		1	1
60033854	Cable entry (IP54)	1	1	1	1	1								1	1	1	1	1							
60018855	Base for Ctrl Interface card	1	1	1	1	1	1	1	1	1	1	1	1	1	1	1	1	1	1	1	1	1	1	1	1
60018863	IP 21 casing	1	1	1										1	1	1									
60018871	IP 21 casing				1	1											1	1							
60031436	IP 21 casing						1	1											1	1					
60031444	IP 21 casing								1	1	1	1	1							1	1		1	1	1
60033897	IP 54 casing	1	1	1										1	1	1									
60033901	IP 54 casing				1	1											1	1							
60033919	IP 54 casing						1	1											1	1					
60033927	IP 54 casing								1	1	1	1	1								1	1	1	1	1
60033935	Screw terminal set (X1...X3) 6 mm ²				1	1											1	1							
60033943	Screw terminal set (X1...X3) 10 mm ²						1												1						
60033951	Screw terminal set (X1...X3) 16 mm ²							1												1					
60033960	Screw terminal set (X1...X3) 25 mm ²								1	1	1										1	1	1		
60036403	Screw terminal set (X1...X3) 70 mm ²											1	1											1	1
60033978	Internal brake module SAGS 30BR	1	1	1										1	1	1									
60033986	Internal brake module SAGS 50BR				1	1											1	1							
60033994	Internal brake module SAGS 100BR						1	1											1	1					
60034001	Internal brake module SAGS 200BR								1	1	1	1	1								1	1	1	1	1

11 Technical Data

Mains Connection

Voltage:

ACS 501-004-3 ... ACS 501-060-3:
3 phase, 380 V, 400 V and 415 V *)
± 10 % permitted tolerance

ACS 501-005-5 ... ACS 501-070-5:
3 phase, 440 V, 460 V, 480 V and 500 V *)
± 10 % permitted tolerance

*) $U_{1max} = 415 \text{ V}; 500 \text{ V}$

Frequency: 48 ... 63 Hz

Power factor: for fundamental ~ 0.98,
0.95 at nominal point

Motor Connection

Output voltage: 3~, 0 ... U_{mains} (U_{max} at
field weakening point)

Output frequency:
0 ... 120 Hz or 0 ... 500 Hz

Frequency resolution: 0.01 Hz

Switching frequency: 1 ... 12 kHz

Continuous output current:
Constant torque: SAMI GS rated I_N
Squared torque: SAMI GS rated I_{NSQ}

Overload capacity:

Constant torque: $1.5 * I_N$,
for 1 min every 10 min

Squared torque: $1.1 * I_{NSQ}$,
for 1 min every 10 min

Starting duty: $2.0 * I_N$ (approx. $1.4 * I_{NSQ}$) for
2 s every 15 s

Field weakening point: 30 ... 500 Hz

Acceleration time: 0.1 to 1800 s/120 Hz

Deceleration time: 0.1 to 1800 s/120 Hz

Environmental limits

Ambient operating temperature

I_N : ($f_s = 3 \text{ kHz}$) 0 to +45°C, except for ACS
501-006-3 and ACS 501-
009-5 0 to +40°C

I_{NSQ} : ($f_s = 3 \text{ kHz}$) 0 to +40°C, except for ACS
501-006-3 and ACS 501-
009-5 0 to +35°C

Also refer to pages 12 and 13 for output
current derating curves.

Storage temperature: -40 to +70 °C

Cooling method: Internal fan

Corrosiveness of cooling air: up to G1
as specified in ISA-S71.04

Relative humidity: max. 95%, no
condensation allowed

Altitude: max. 1000 m above sea level
(100 % load), 1 % derating every 100 m
above 1000 m

External control connections

Two programmable Analogue Inputs:

Voltage reference: 0(2) ... 10 V, 200 kΩ
single ended

Current reference: 0(4) ... 20 mA, 250Ω
single ended

Potentiometer reference:
10 V -0/+1 %, 10 mA

Auxiliary voltage: +24 V DC, max. 200 mA

Six programmable Digital Inputs

$3.0 \cdot I_N$ instantaneous, $2.1 \cdot I_N$ (RMS)

Two programmable Analogue Outputs

Overvoltage trip limit: $1.35 \cdot U_{1max}$

0(4) ... 20 mA, 500Ω

Undervoltage trip limit: $0.65 \cdot U_N$

Three programmable Relay Outputs

Overtemperature limit:

max. switching voltage 300 V DC/250 V AC

ACS 501-004-3 to 041-3: +70 °C heatsink

max. switching current 8 A/24 V DC,
0.4 A/250 V DC

ACS 501-005-5 to 050-5: +70 °C heatsink

max. switching power 2000 VA/250 V AC

ACS 501-050-3, 060-3: +75 °C heatsink

ACS 501-060-5, 070-5: +75 °C heatsink

max. continuous current 2 A

Undertemperature limit: -5 °C heatsink

Serial link bus:

RS 485, ACS 500 protocol, maximum 31 ACS 500 series units. Auxiliary voltage supply for remote control panel SAGS 700 PAN.

Auxiliary voltage: short-circuit protected

Earth fault protection: protects only the inverter itself in case of earth fault at motor output

Microprocessor fault: protected

Protections

Motor stall protection

Overcurrent trip limit:

$3.57 \cdot I_N$ instantaneous, $2.65 \cdot I_N$ (RMS)

Motor overtemperature protection

Slow current regulation limit:

max. $1.5 \cdot I_N$ (RMS)

Enclosure

Enclosure classes: IP 21 and IP 54

Rapid current regulation limit:

max. $2.0 \cdot I_N$ (RMS)

Dimensions and weight: see page 15

Current switch-off limit:

12 Options

Remote control box

SACE 11 BOX, SACE 12 BOX,
SACE 20 BOX, SACE 21 BOX

A remote control box is an external control device connected to the terminal block of the Control Interface Card or an Optional Control Card.

Remote control panel

SACE 11 PAN, SACE 12 PAN

A remote control panel is an external control device connected to the terminal block of the Control Interface Card or an Optional Control Card. The panel is mounted in the operator's control desk or cubicle.

Remote control panel SAGS 700 PAN

A remote control panel can be used to control a maximum of 31 ACS 500 frequency converters individually or all together. The panel is connected on Terminal X 51 to RS 485 interface. In addition to Standard Control Panel functions, the panel also has additional features such as network control, up- and down loading of parameters (e.g. between drives) and common drive control for all connected drives. The panel functions as a master controller for bus-connected drives but it can be set to a HOLD state where it cannot send or receive messages.

For further information please refer to the User Manual EN 58057584.

Input/Output Extension Card SNAT 7520 IOE

SNAT 7520 IOE is an input/output extension card with three digital and two analogue inputs, two analogue and two relay outputs. It can be used, for example, with PFC Control when more than 3 motors are to be controlled. In general, it can be used in applications

requiring galvanically isolated inputs and outputs.

For further information please refer to the Installation and Operation Guide EN 58057843.

Bus Adapter and Pulse Tachometer Interface Card SNAT 7610 BAC

SNAT 7610 BAC is a bus adapter and pulse tachometer interface card which includes a speed control Application Macro. The Tachometer interface includes three galvanically isolated tachometer signal channels.

The Communication board interface enables connection of an ABB high speed serial communication board with an ISBX connector.

For further information please refer to the Installation and Operation Guide EN 58057835.

Profibus Interface Card SNAT 7700 PRI

SNAT 7700 is a serial communication board that enables a PLC or PC to control an ACS 500 series frequency converter through Profibus compatible communication channel.

For further information please refer to the Installation and Operation Guide EN 61096710.

Dynamic braking device

Effective motor braking and thus short deceleration times are achieved by using an internal braking chopper with an external resistor.

RFI filter

An RFI (Radio Frequency Interference) filter should be used when extremely sensitive equipment is in the vicinity of the SAMI GS.

13 Glossary

Brake control

If the deceleration time (Group 21) is set very short and the motor load has high inertia, the DC bus voltage will rise too high causing a fault indication during braking. If the deceleration time cannot be set longer, an optional brake control device (dynamic braking device) must be used.

DC bus

Intermediate DC link where the mains voltage is rectified and filtered. The nominal DC bus voltage corresponds $1.35 * U_1$.

Default

Value provided for a parameter as a part of the program when the drive is started initially (= factory setting).

EEPROM

Electrically Erasable Programmable Read Only Memory. Memory that can be changed with an electrical signal, but retains the data when power is removed. The parameters and the control programs are stored in the EEPROM.

Field weakening point

Refer to page 58.

IR compensation

Refer to page 58.

Joystick control

Refer to page 39.

Living zero

Setting the minimum value of the Analogue Input to 4 mA (2 V) provides the operator with a "living zero" function. The existence of a control signal can then be supervised by

setting the parameter 32.2 AI <2V/4mA FUNC to WARNING or FAULT, which causes a warning/fault indication if input is less than 4 mA (2 V).

Memory

Place where data and instructions are stored for use by the program.

Parameter

A memory address that is used to store data for use by the program. The complete table of parameters is presented on pages 33-36.

Slip compensation

Refer to page 59.



ABB Industry Oy
VSD Products
P.O. Box 184
FIN-00381 Helsinki
FINLAND
Telephone +358-0-5641
Telefax +358-0-5642681
Telex +57-12440502strfi

1995-08-07

EN60019134C